

<b>M</b>	Squall Breakout		REV: A
	Author: Brad Campbell		
	Date: 3/12/15 6:16 PM	Sheet: 1/1	

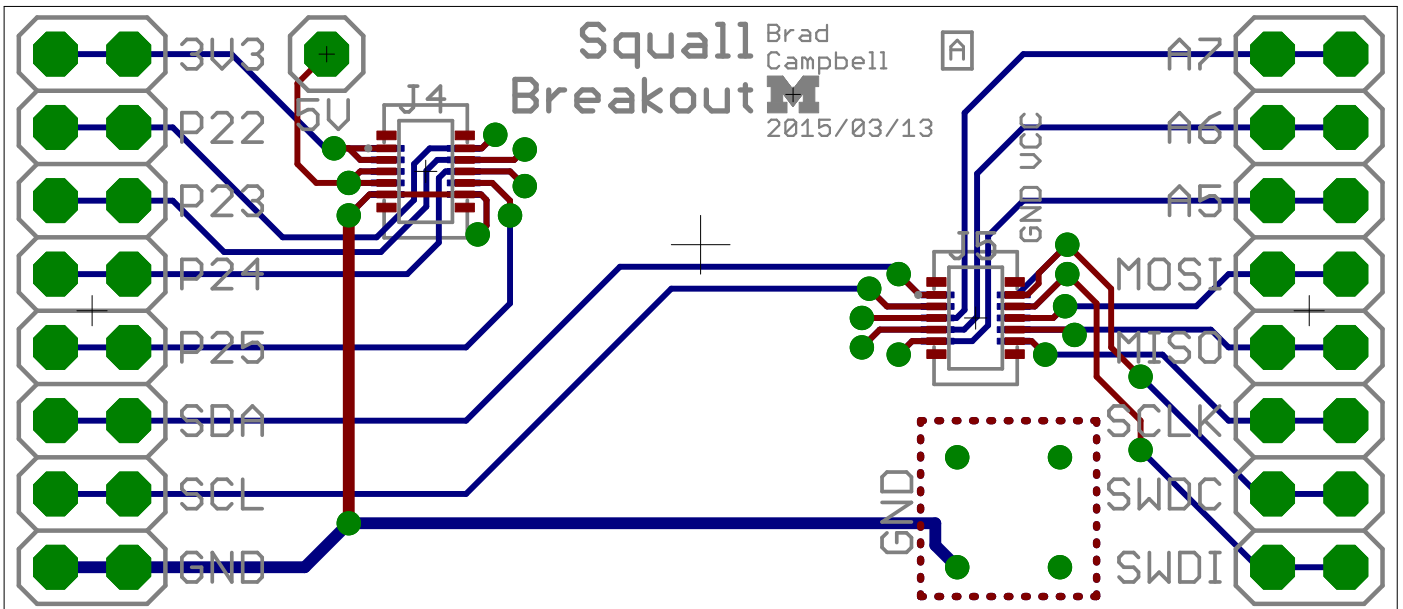

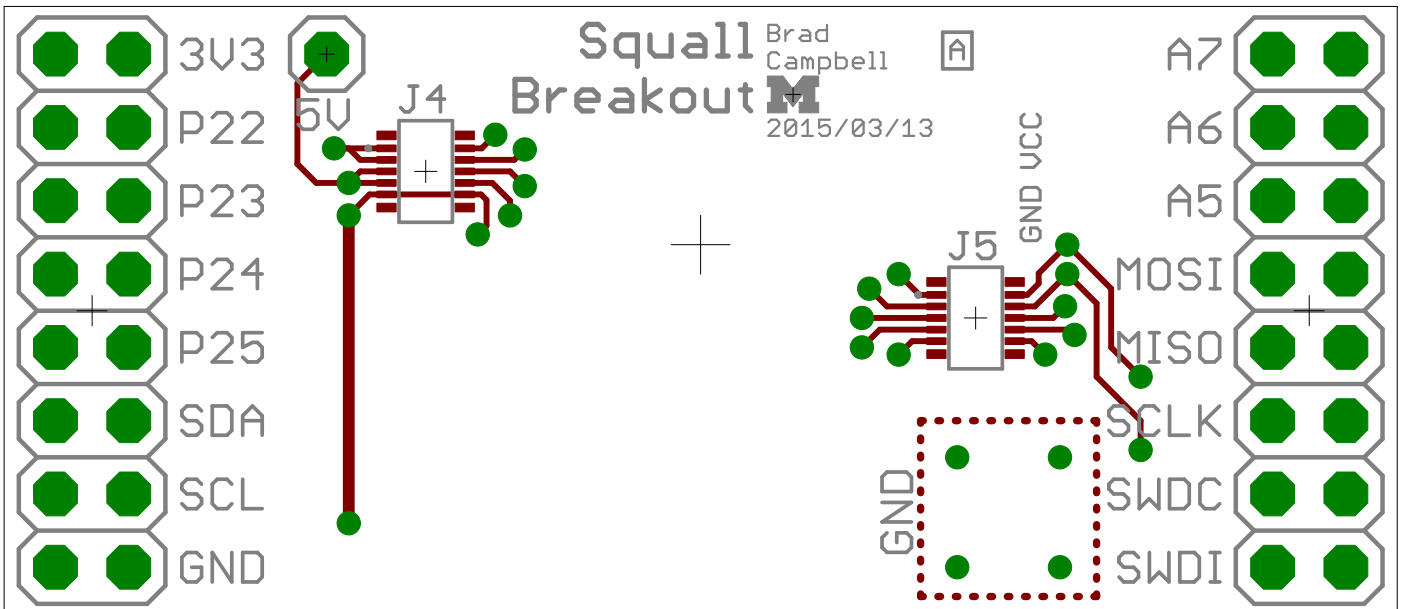

Bottom Layer

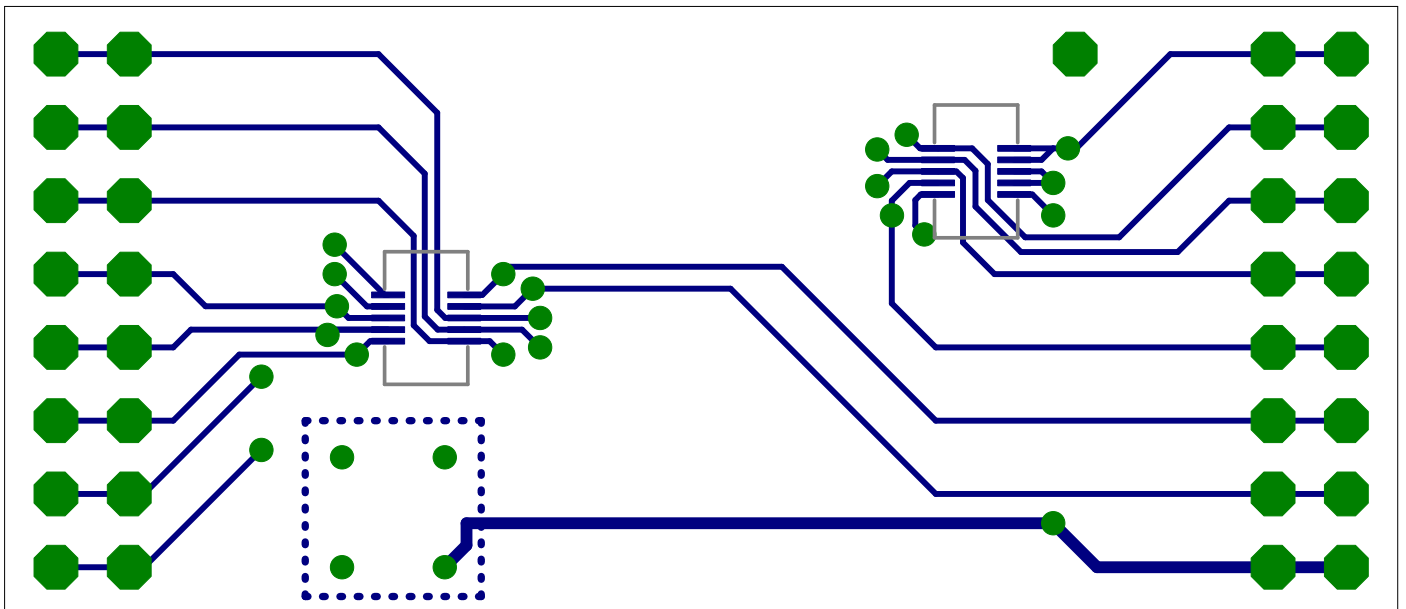

Top Copper Layer

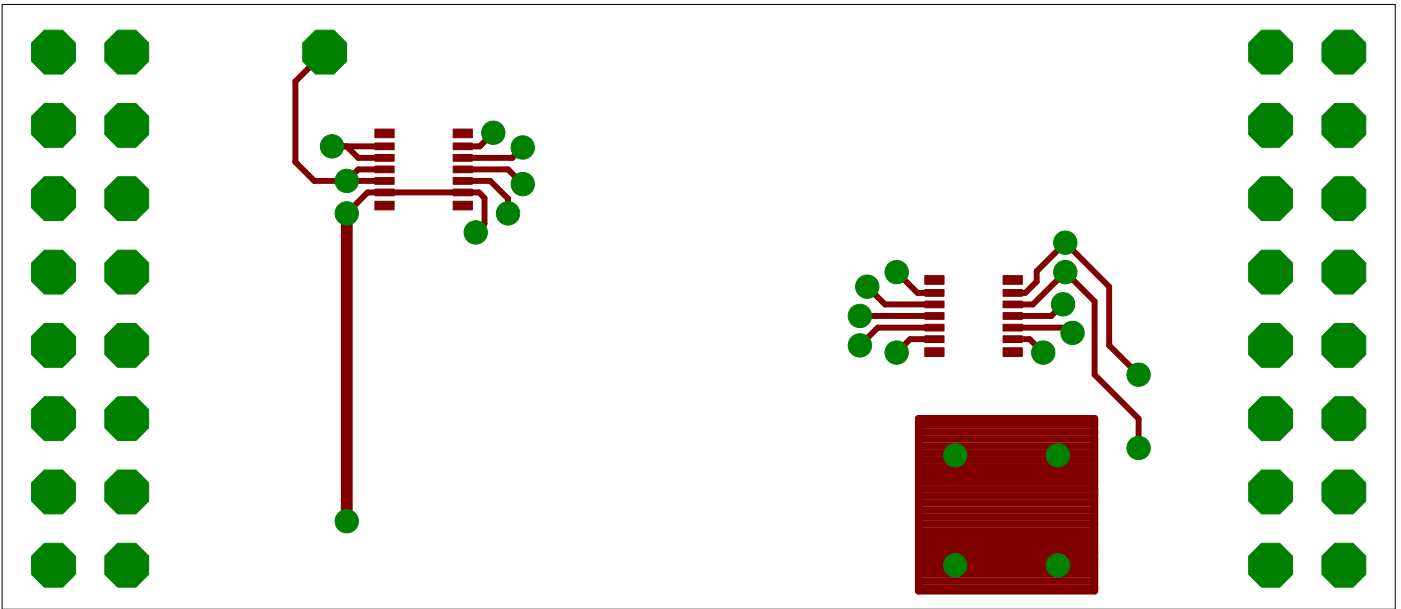

Bottom Copper Layer

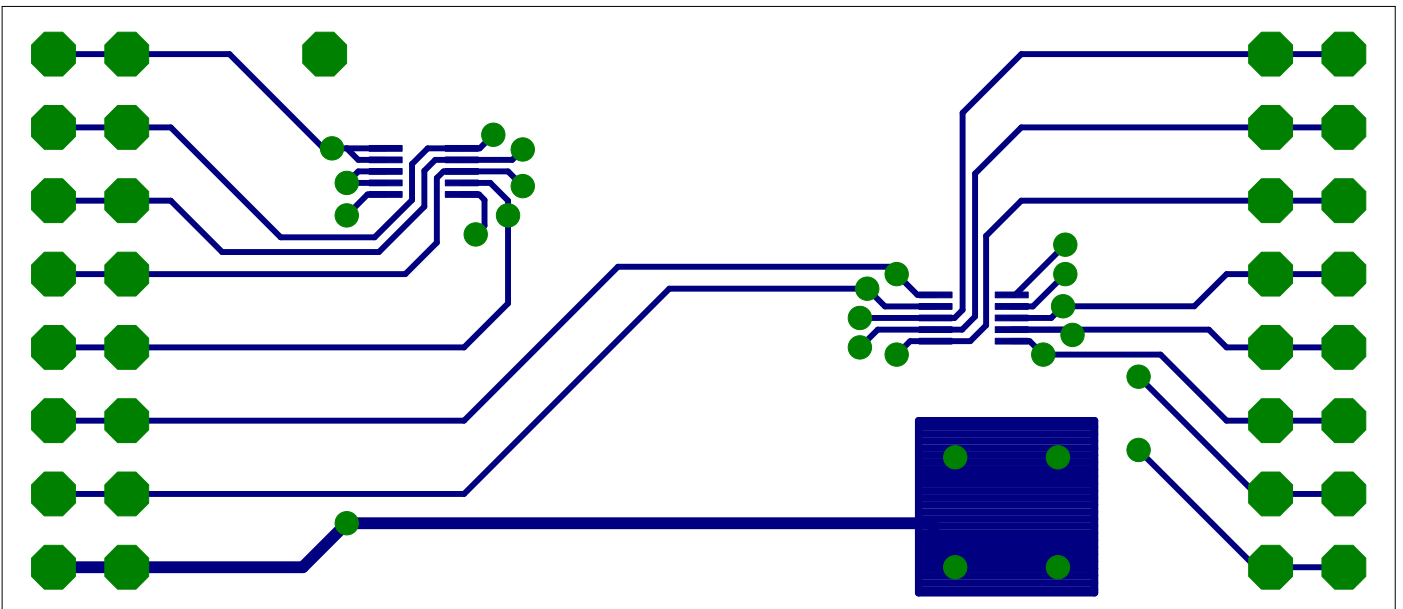

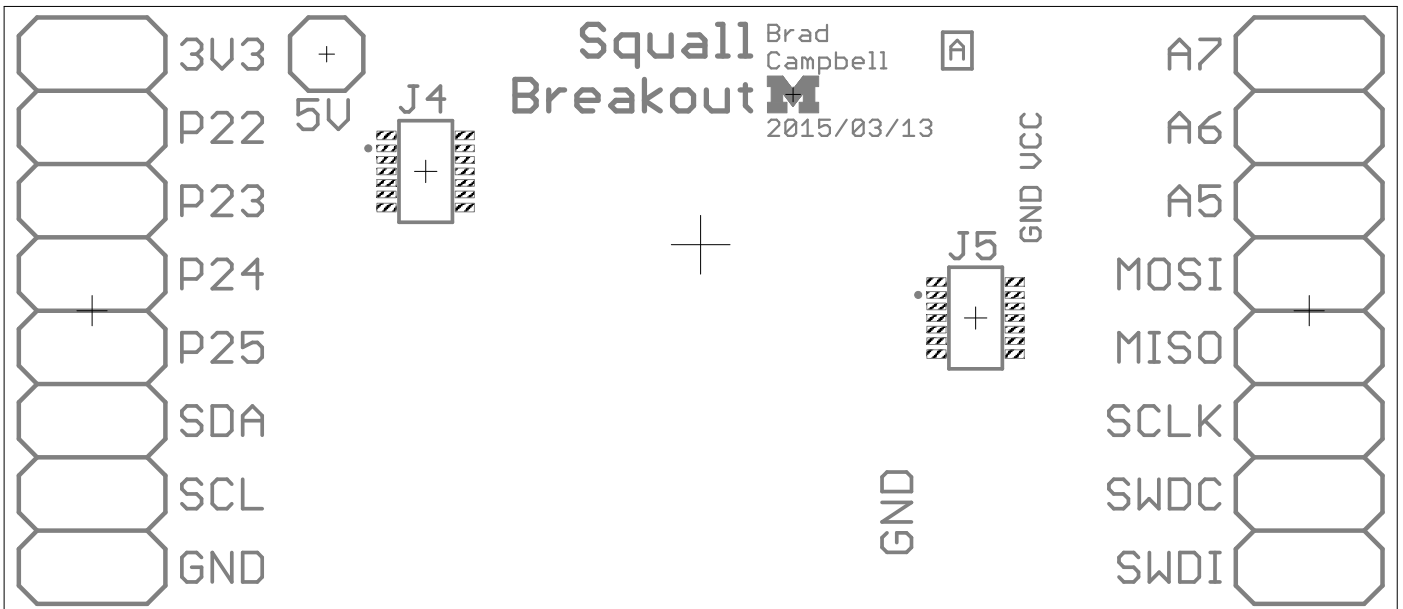

Bottom Paste Layer with Silkscreen

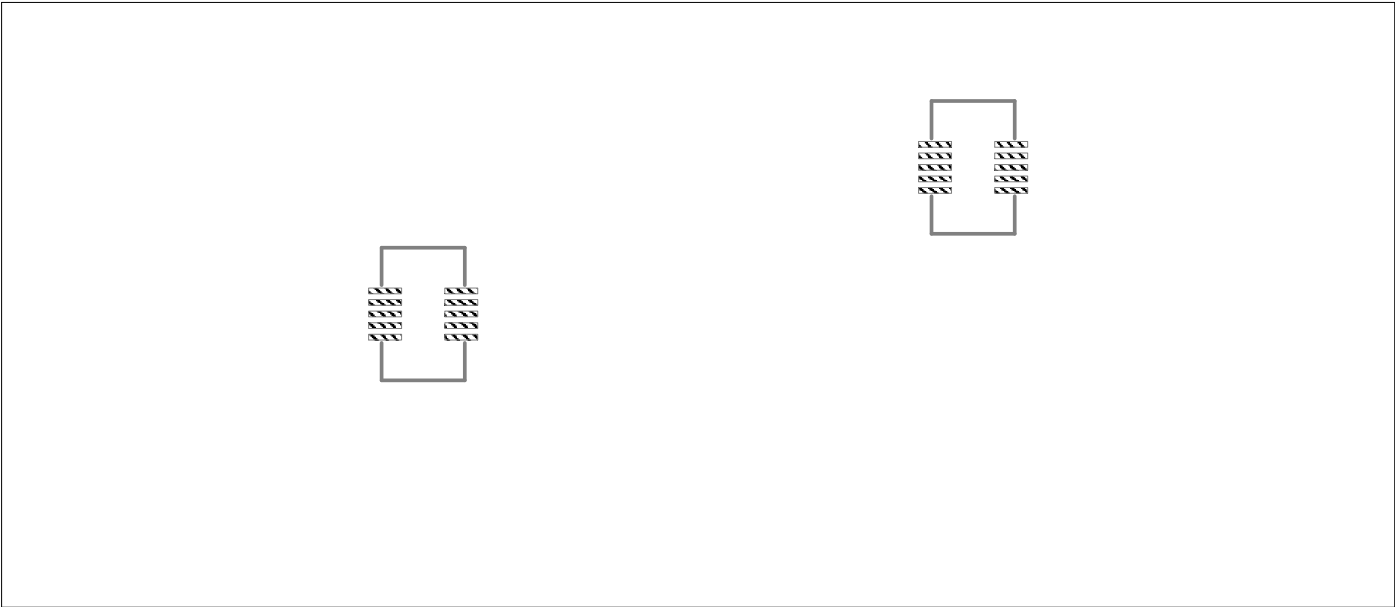



Top and Bottom Layers 1:1 Scale

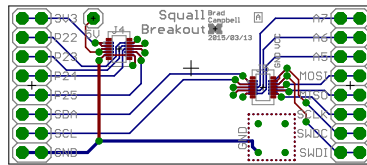

Top Layer 1:1 Scale

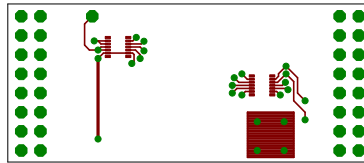

Bottom Copper Layer 1:1 Scale

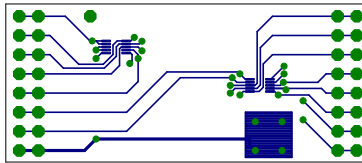

## Sheet1

Qty	Value	Device	Package	Parts
1	10nF	CAPACITOR	0402_CAP	C1
7	0.1uF	CAPACITOR	0402_CAP	C2, C3, C4, C5, C6, C7, C8
1	10uF	CAPACITOR	0402_CAP	C9
1	22uF	CAP_POL0603	CAP0603	C10
3	SFH4056	SFH4056	SFH4056	D1, D2, D3
1	DIODE	DIODE	0402_DIODE	D4
2	SQUALL_HEADER	SQUALL_HEADER	SQUALL_HEADER	J1
1		PINHD-2X2	2X02	J2
1	308-100	308-100	308-100	M1
1	ROHM-NPN-2SC5662	ROHM-NPN-2SC5662	VMT3	Q1
1	30	RESISTOR0402_RES	0402_RES	R1
1	33	RESISTOR0402_RES	0402_RES	R2
1	1k	RESISTOR0402_RES	0402_RES	R3
2	10k	RESISTOR0402_RES	0402_RES	R4, R5
1	LPS331AP	LPS331AP	HCLGA-16/3MM	U1
1	MPU-9250	MPU-9250	QFN-24/3MM	U2
1	SI1147	SI1147	QFN-10/2MM	U3
1	SI7021	SI7021	DFN-6/3MM	U4

Sheet1

<b>Description</b>	<b>DIGIKEY</b>
0402 Capacitor	490-1312-1-ND
0402 Capacitor	490-1318-1-ND
0402 Capacitor	445-8919-1-ND
0603 Tantalum Capacitor	511-1493-1-ND
LED IR EMITTER 850NM	475-3042-1-ND
	641-1277-1-ND
Header for a sensor board on top of the Squall BLE tag board.	H11617CT-ND
PIN HEADER	609-3201-ND
Pico Vibe	
	2SC5662T2LPCT-ND
Resistor	RHM30CECT-ND
Resistor	RHM33CECT-ND
Resistor	RHM1.0KCECT-ND
Resistor	RHM10.0KCDCT-ND
IC PRESSURE SENSOR PIEZO 16HCLGA	497-12927-1-ND
GYRO/ACCEL/COMPASS/9-AXIS	1428-1019-1-ND
SENSOR DGTL UV INDEX 10QFN	336-2624-1-ND
IC TEMP SENSOR RH 2% DFN	336-2542-1-ND

PRECISION\_MICRODRIVES

308-100