

TITLE: nucleum

Document Number: _____ REV: _____

Date: 4/21/15 4:28 PM Sheet: 1/2

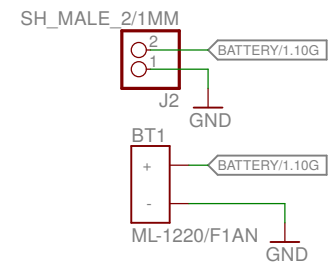
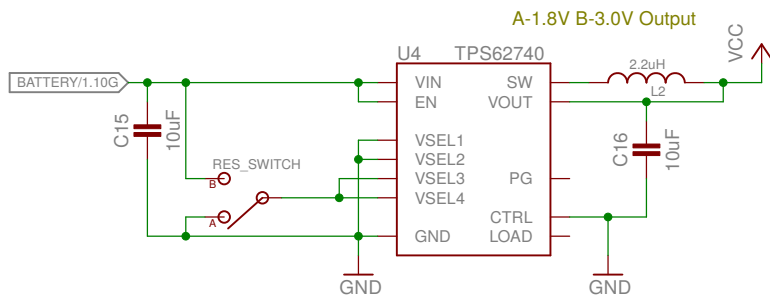

TITLE: nucleus

Document Number:

REV:

Date: 4/21/15 4:28 PM

Sheet: 2/2

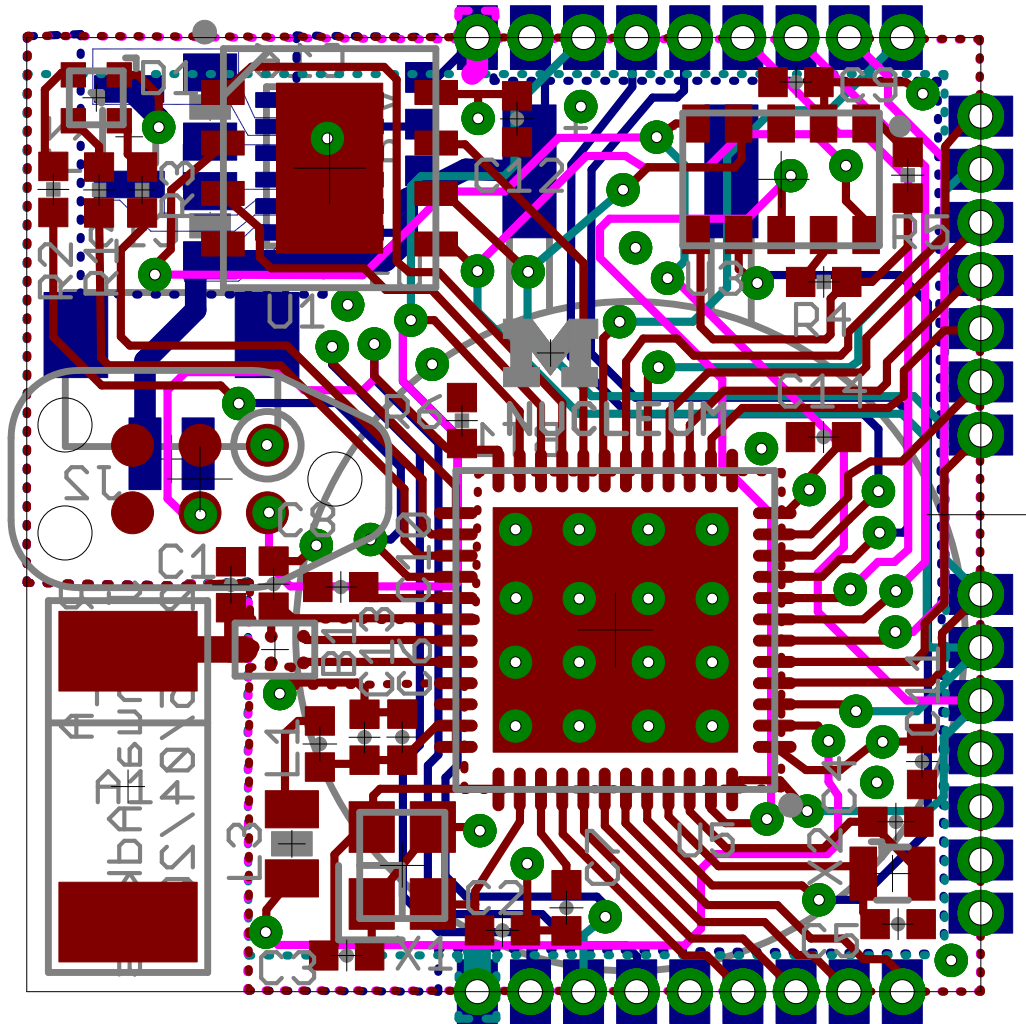

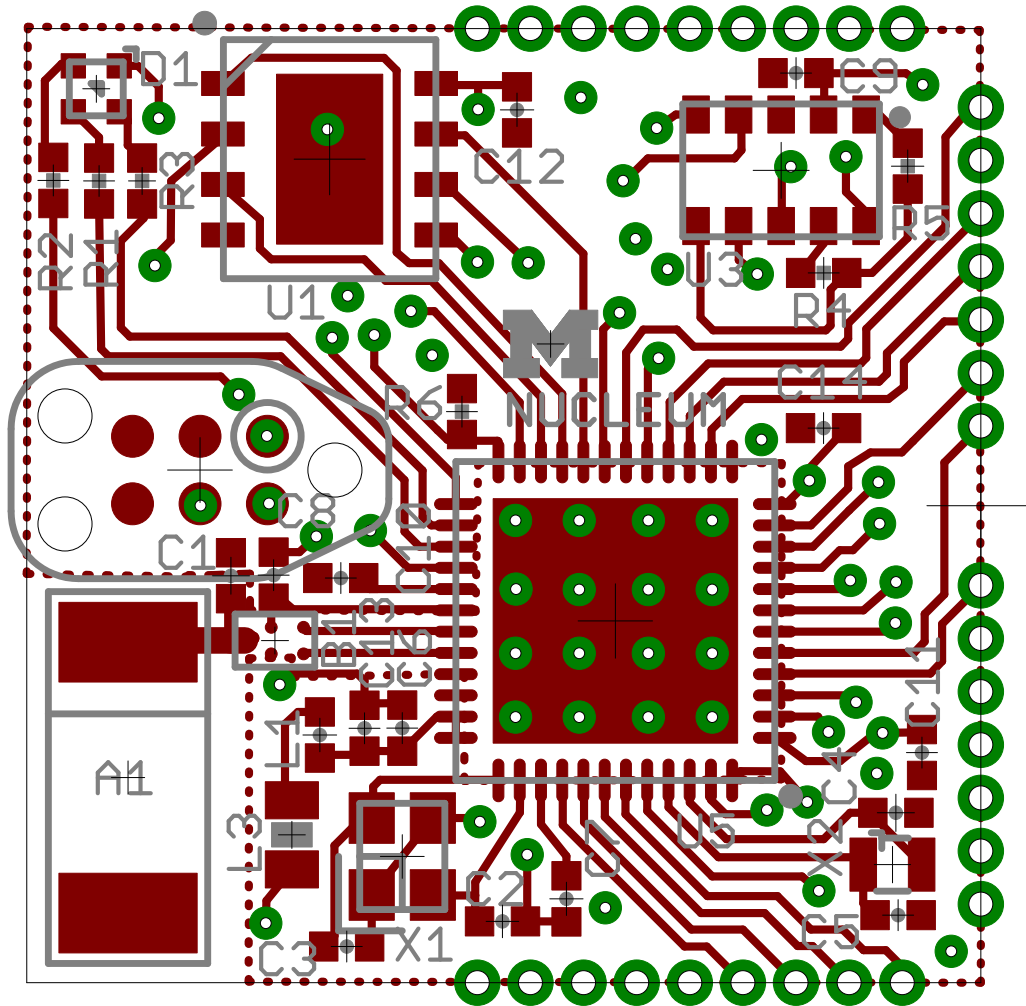

Bottom Layer

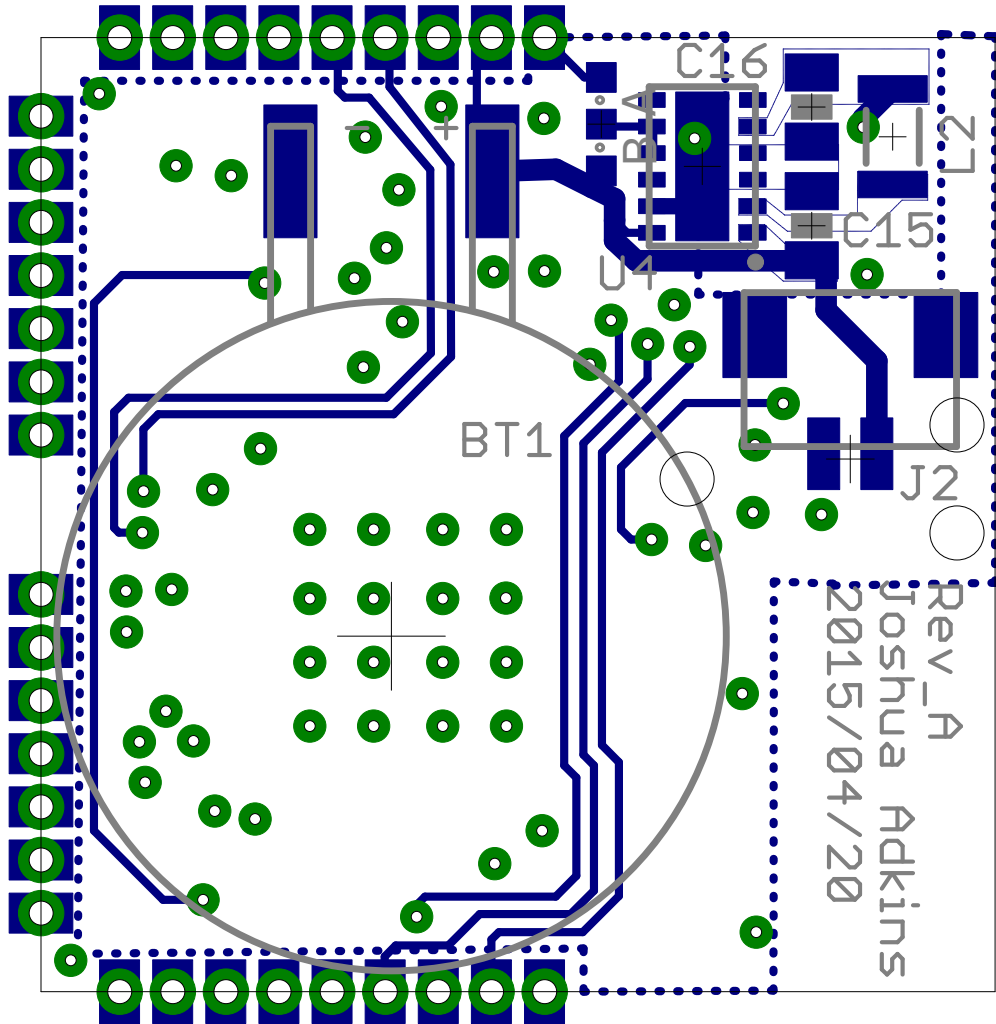

Top Copper Layer

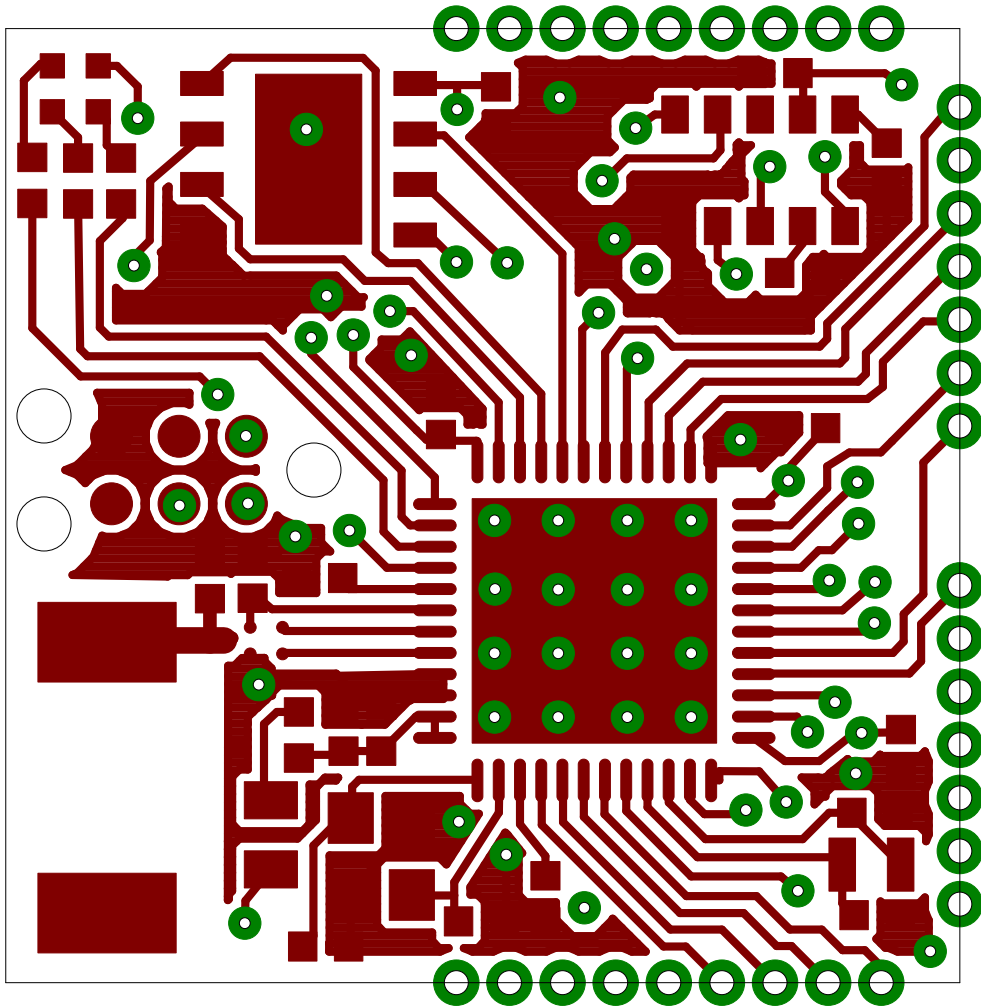

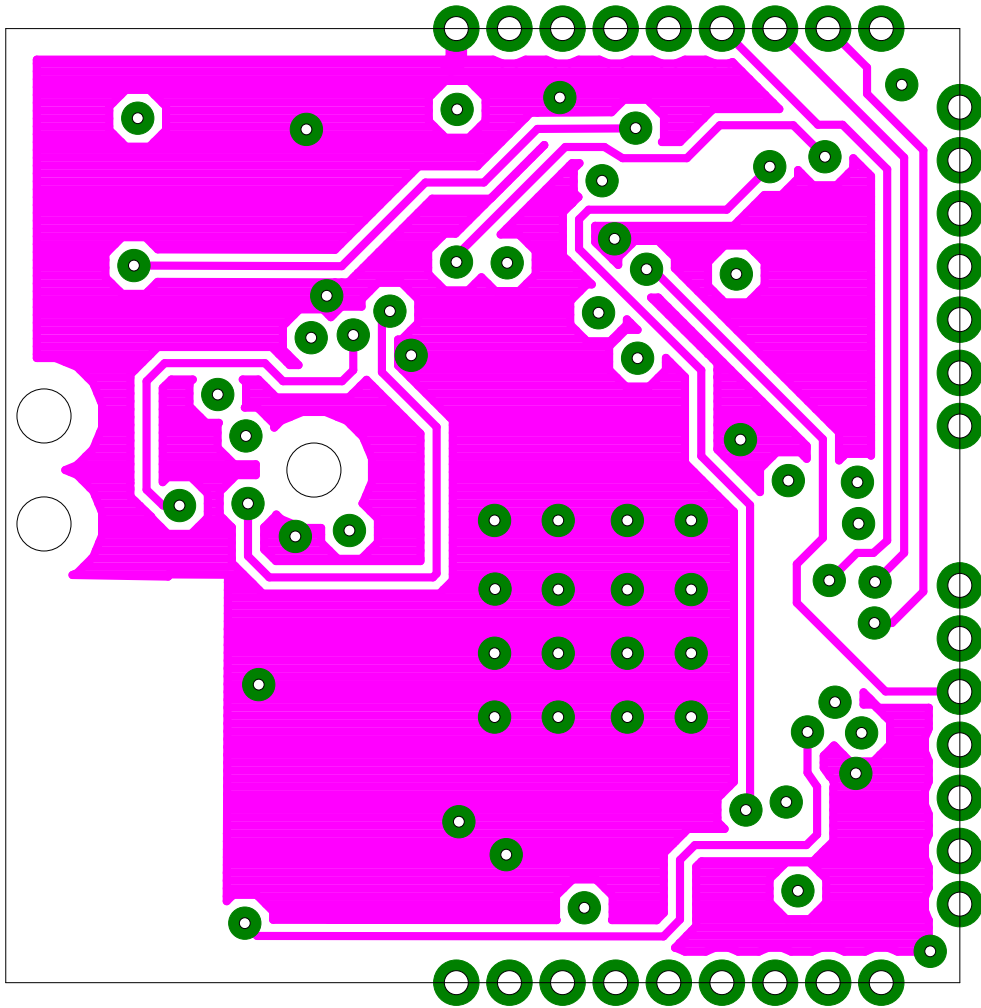

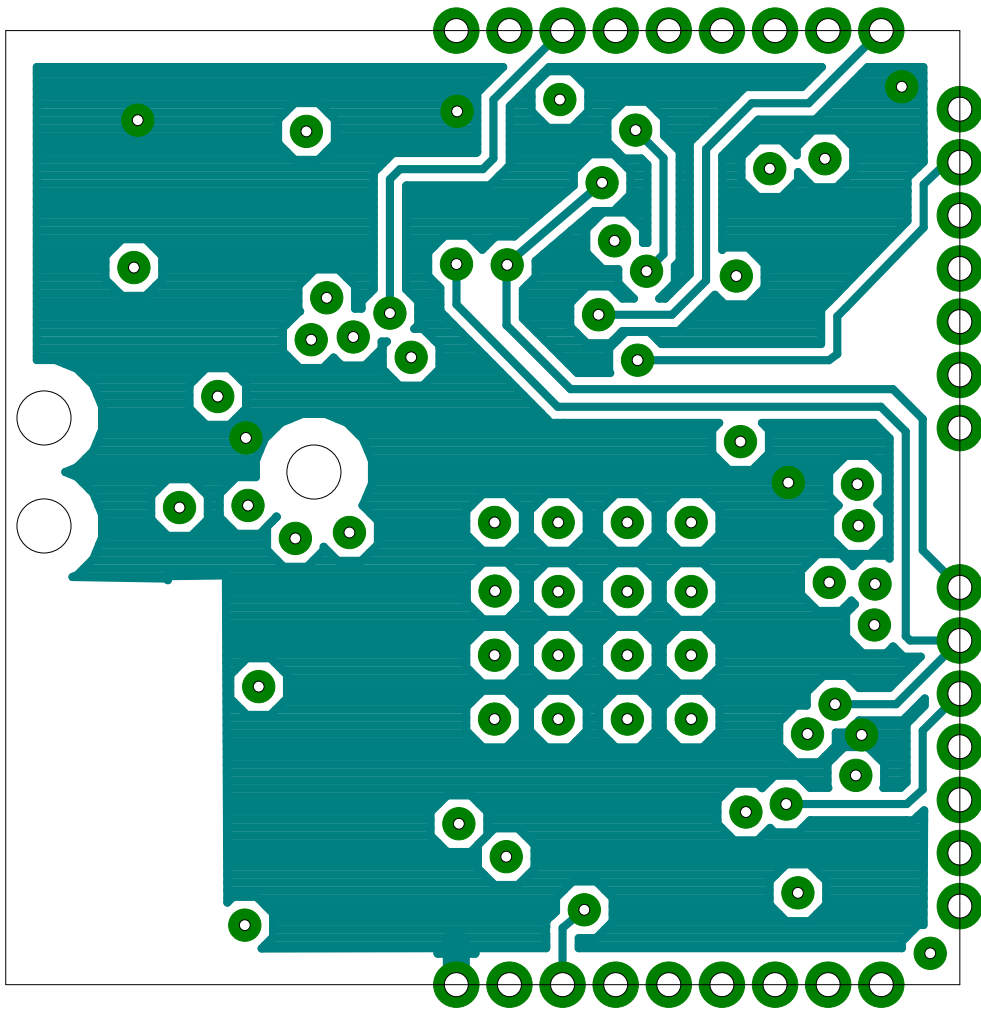

Bottom Copper Layer

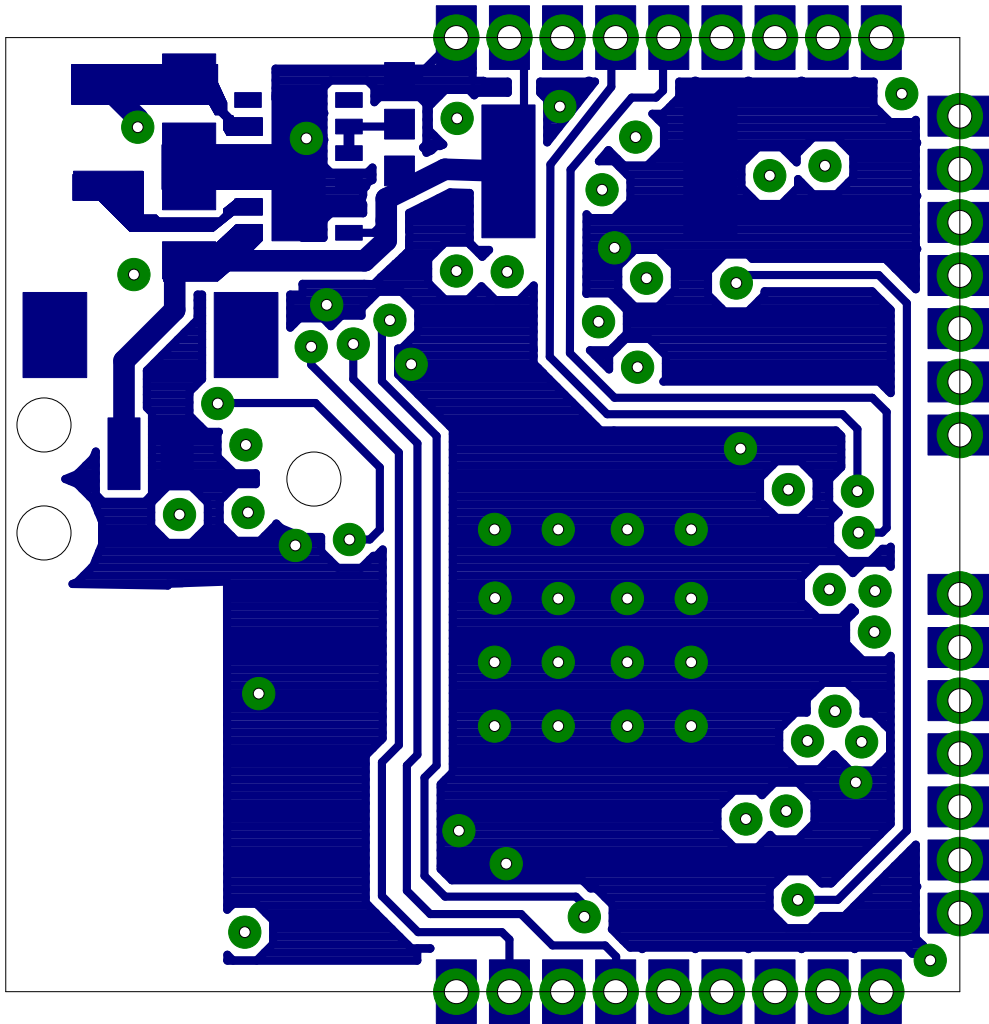

Top Paste Layer with Silkscreen

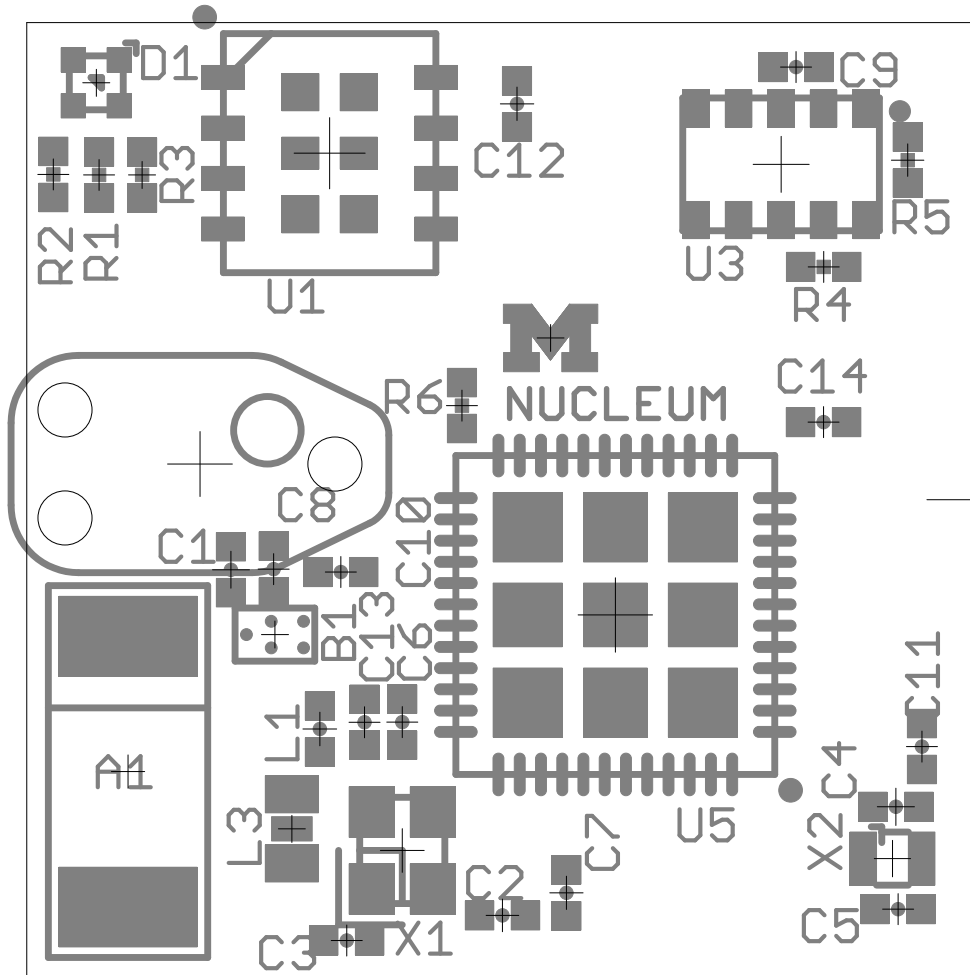

Bottom Paste Layer with Silkscreen

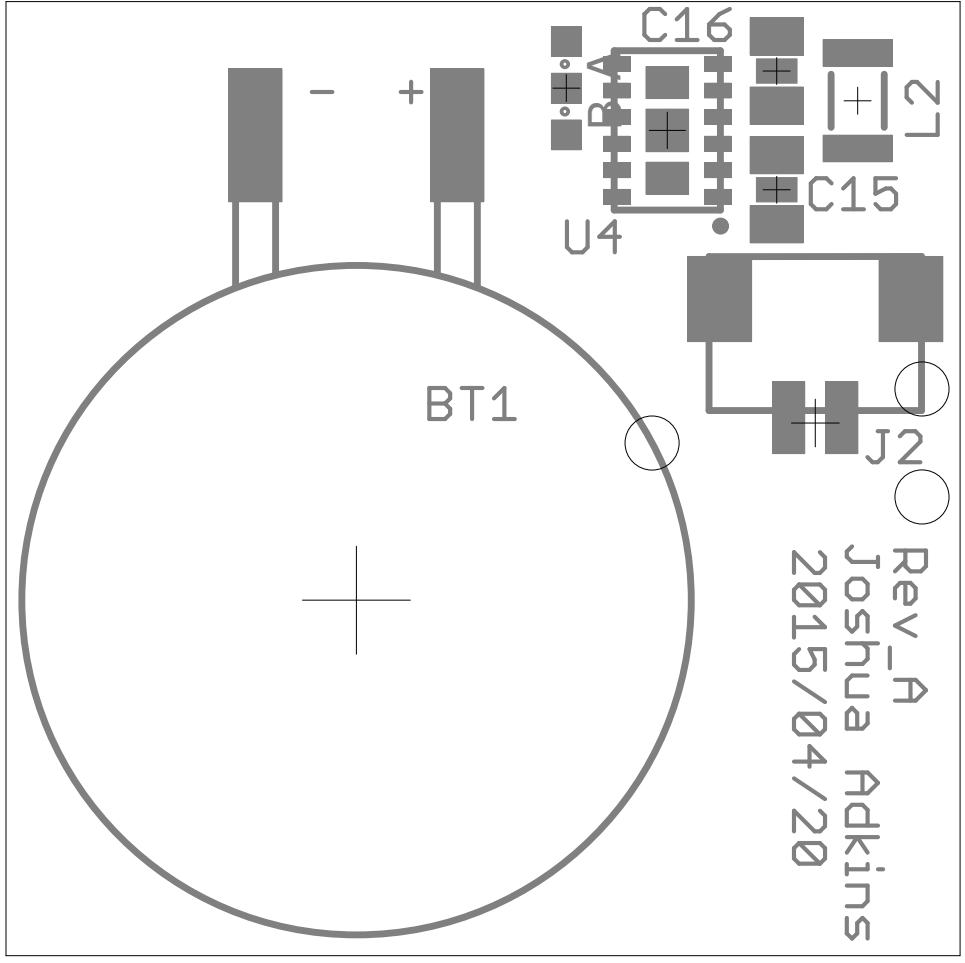

Top and Bottom Layers 1:1 Scale

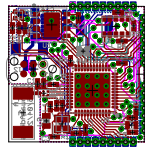

Top Layer 1:1 Scale

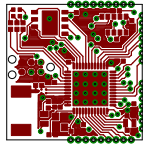

Layer 2 Copper 1:1 Scale

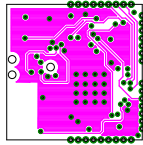

Layer 3 Copper 1:1 Scale

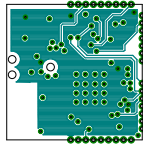

Bottom Copper Layer 1:1 Scale

