

MICRO_USB_B_HIROSE_ZX62R-B-5P

M Epic Multi Programmer

REV:
A

Date: 8/6/13 3:33 PM

Sheet: 1/3

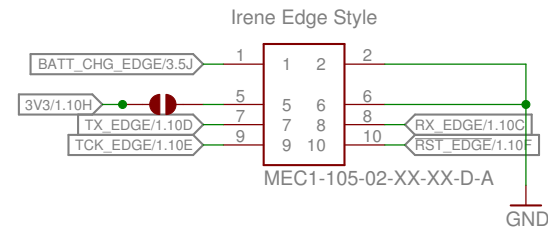
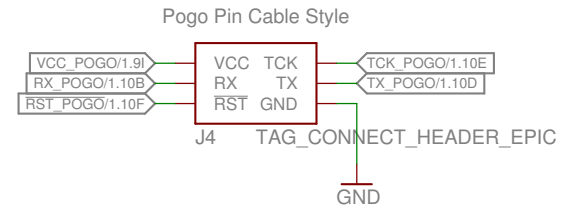
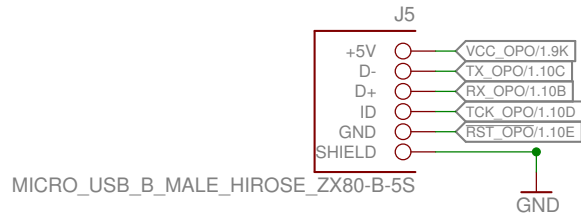

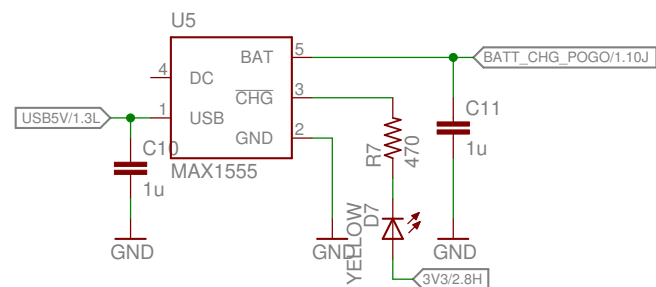
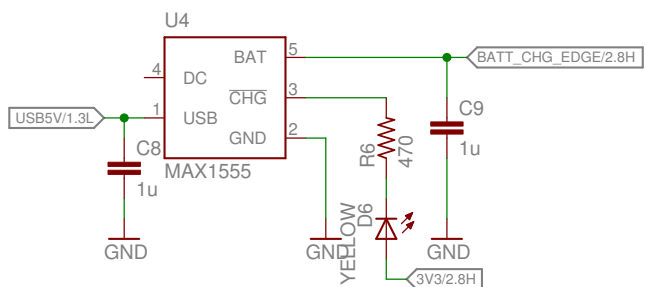
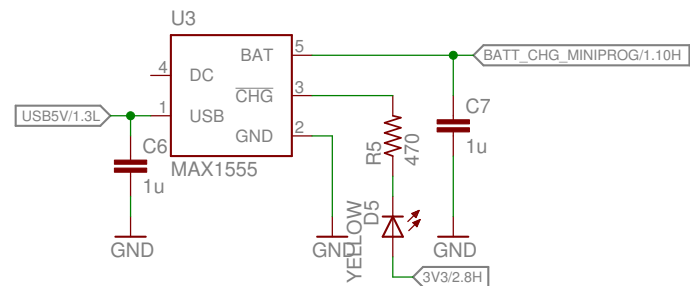
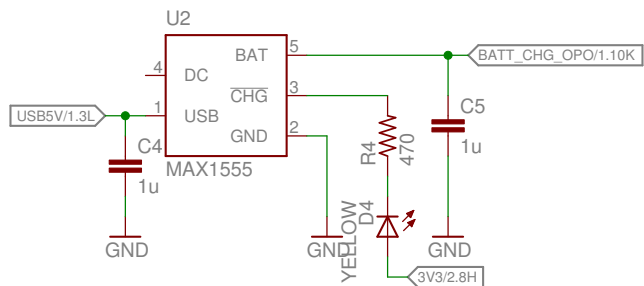

Top and Bottom Layers

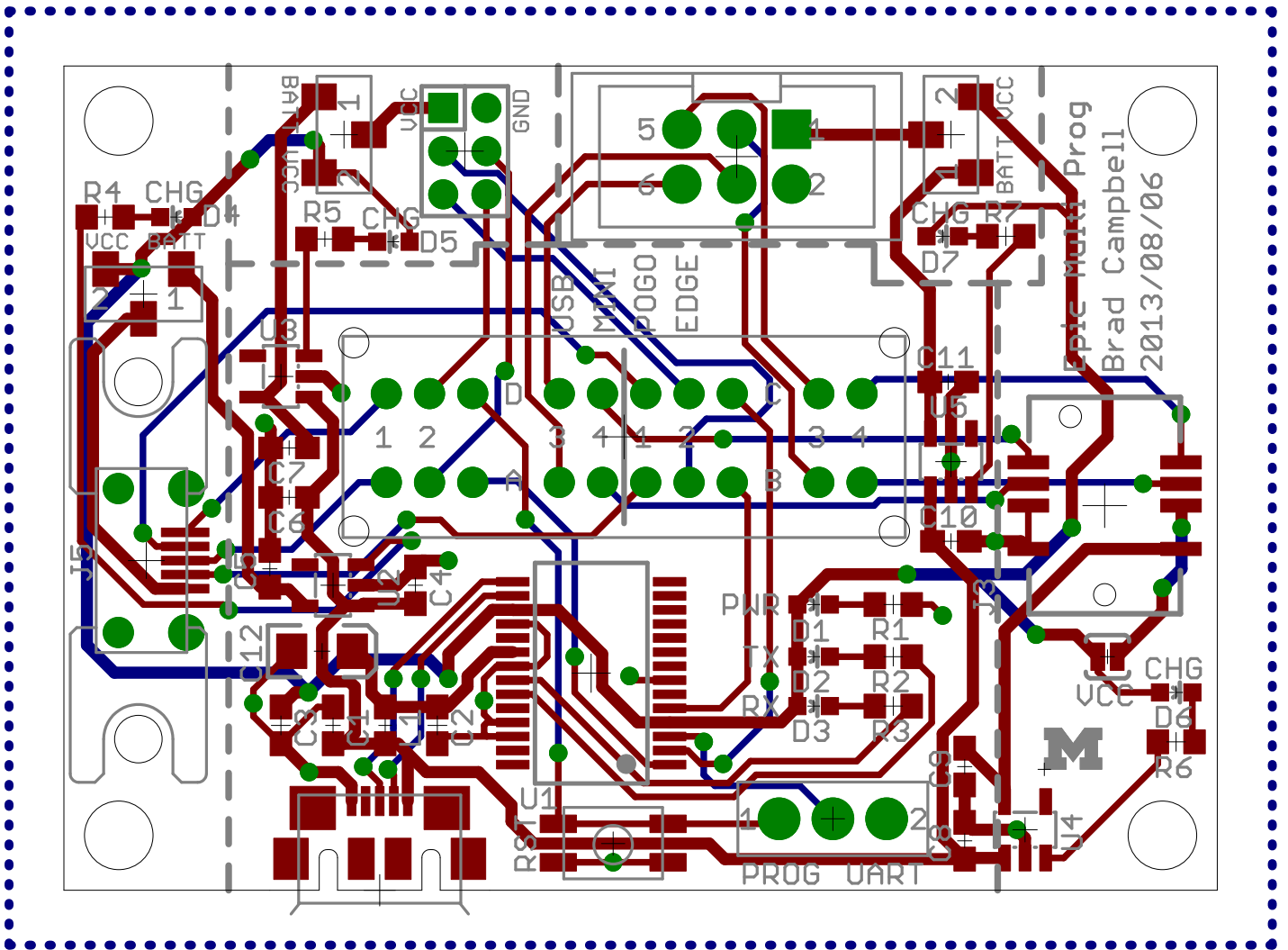

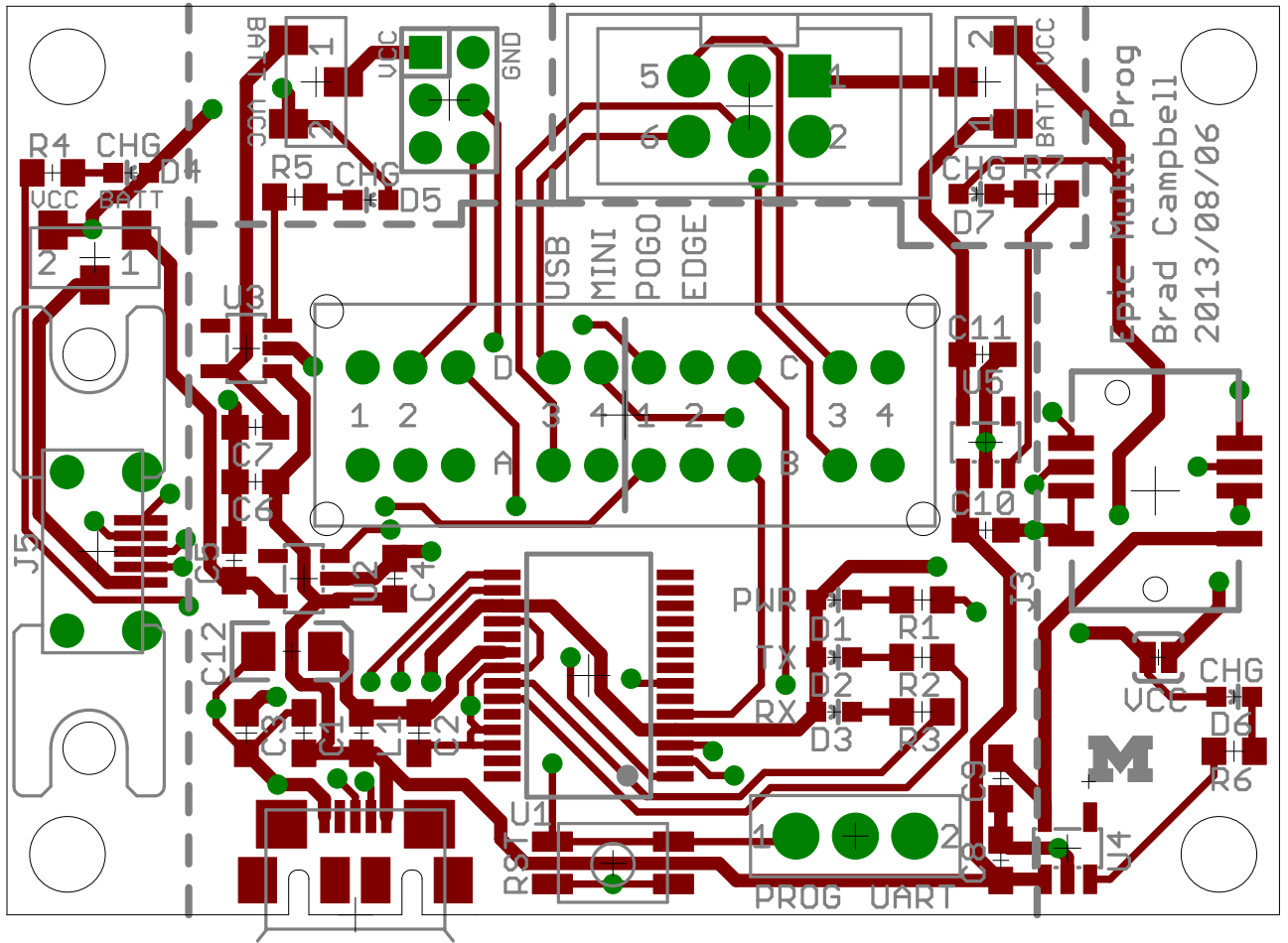

Bottom Layer

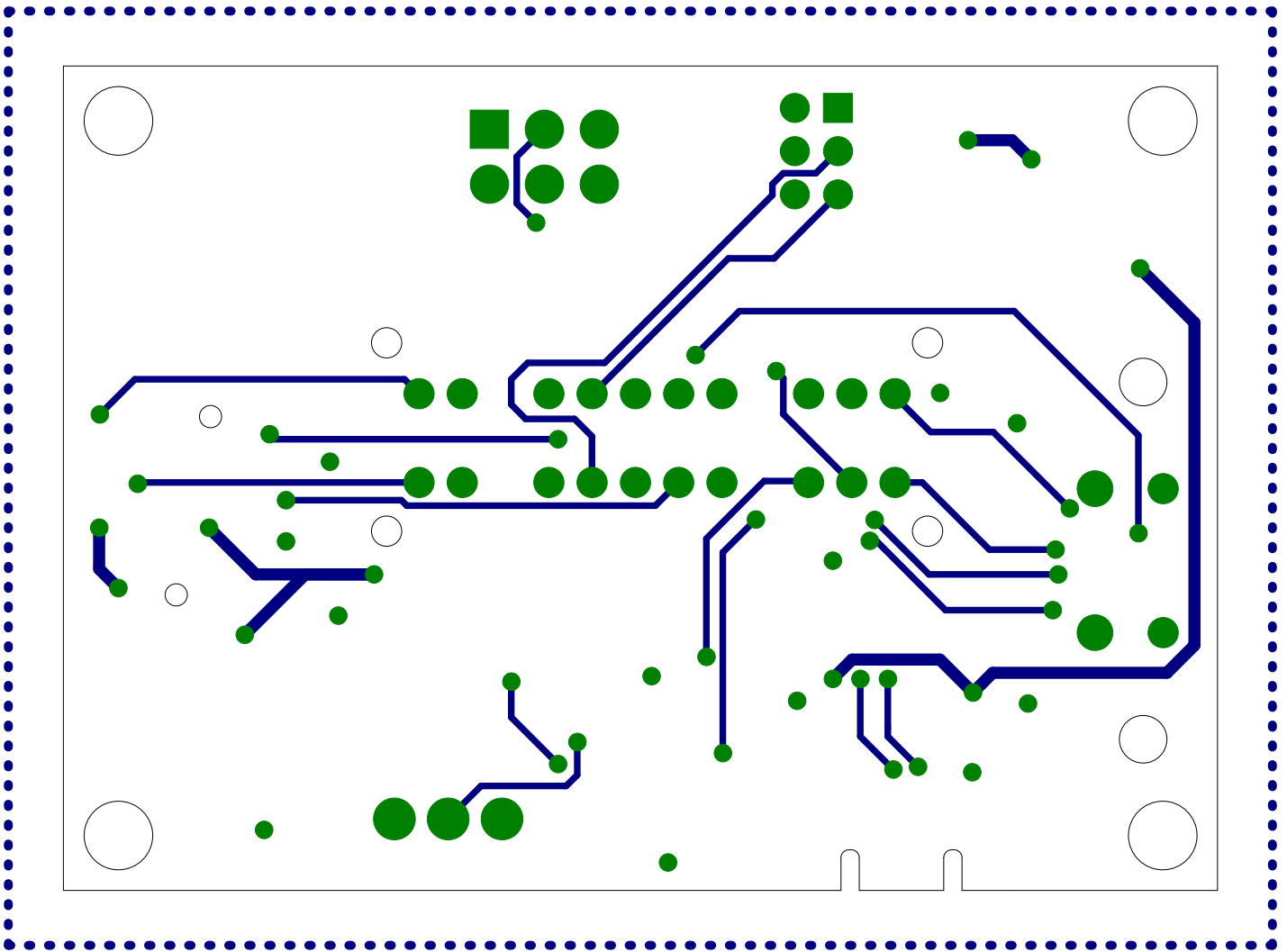

Top Copper Layer

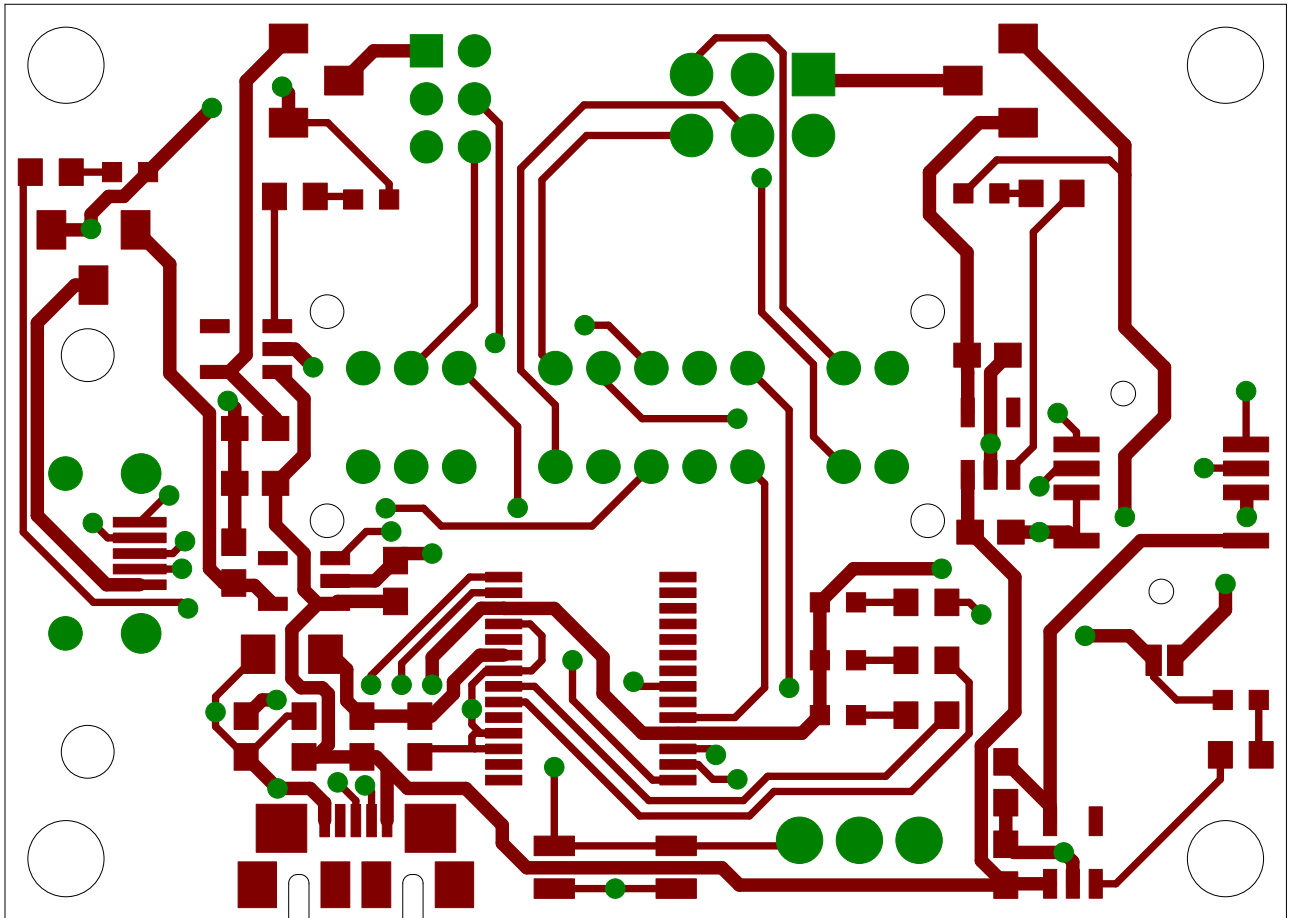

Bottom Copper Layer

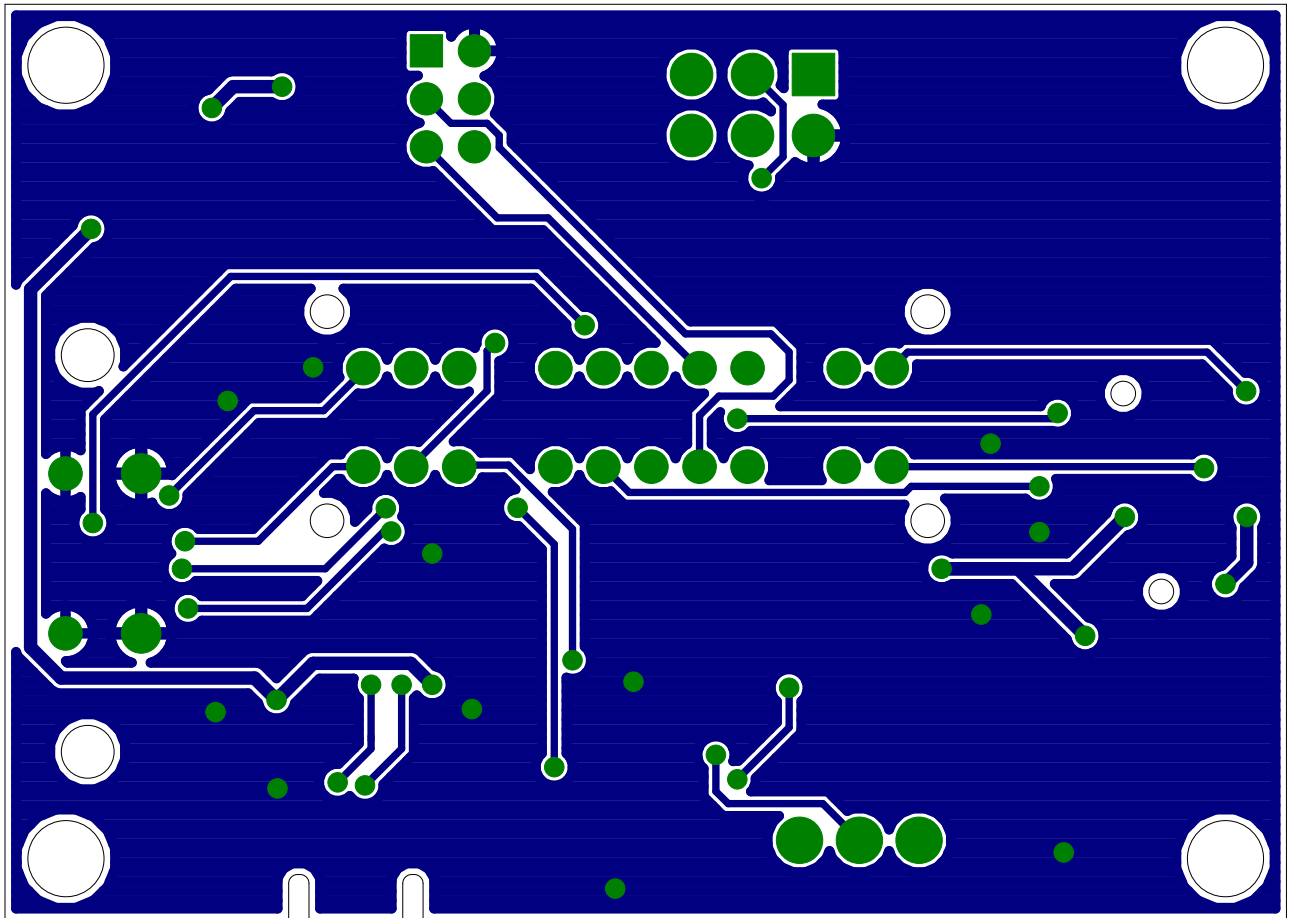

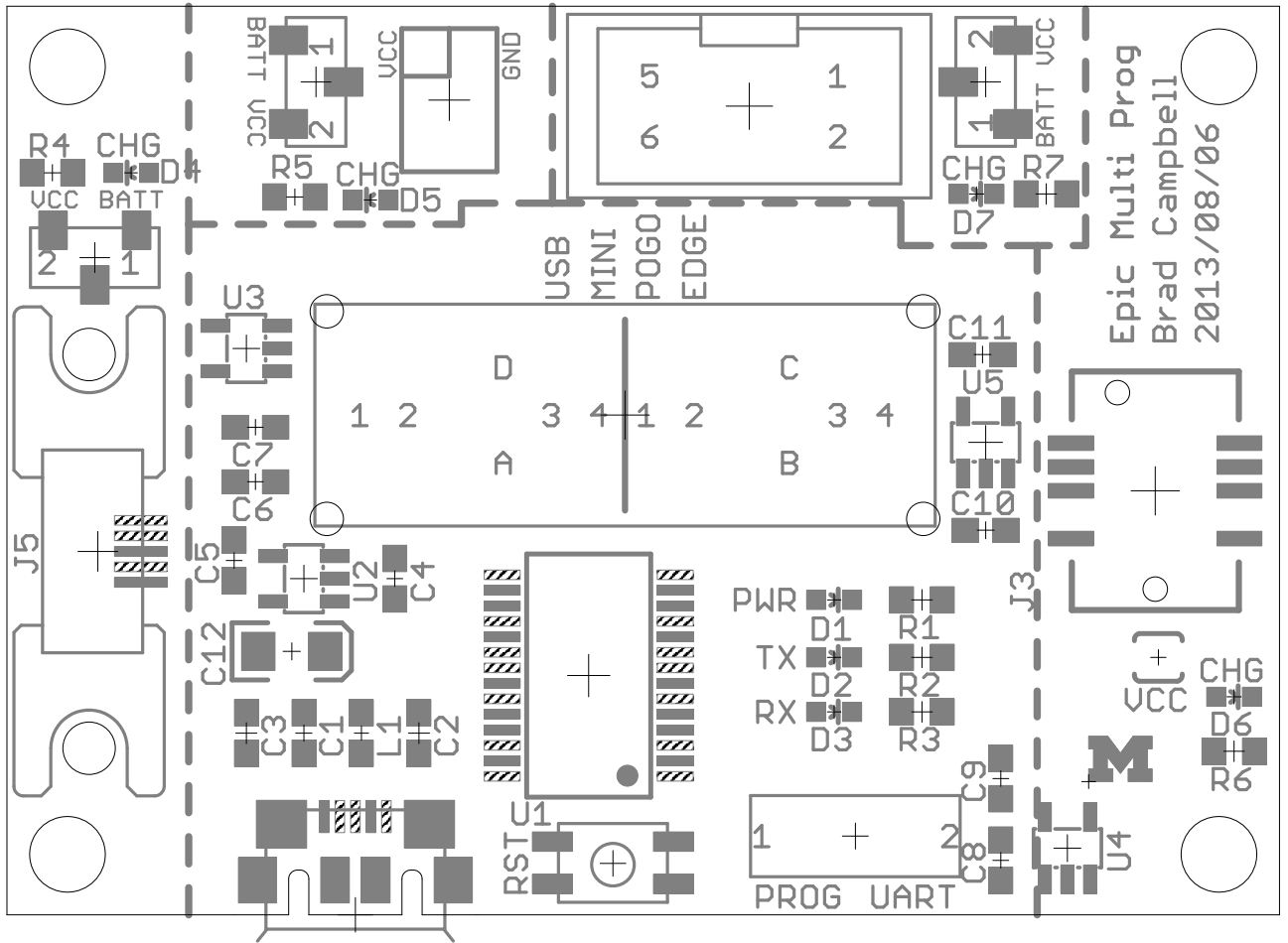

Bottom Paste Layer with Silkscreen

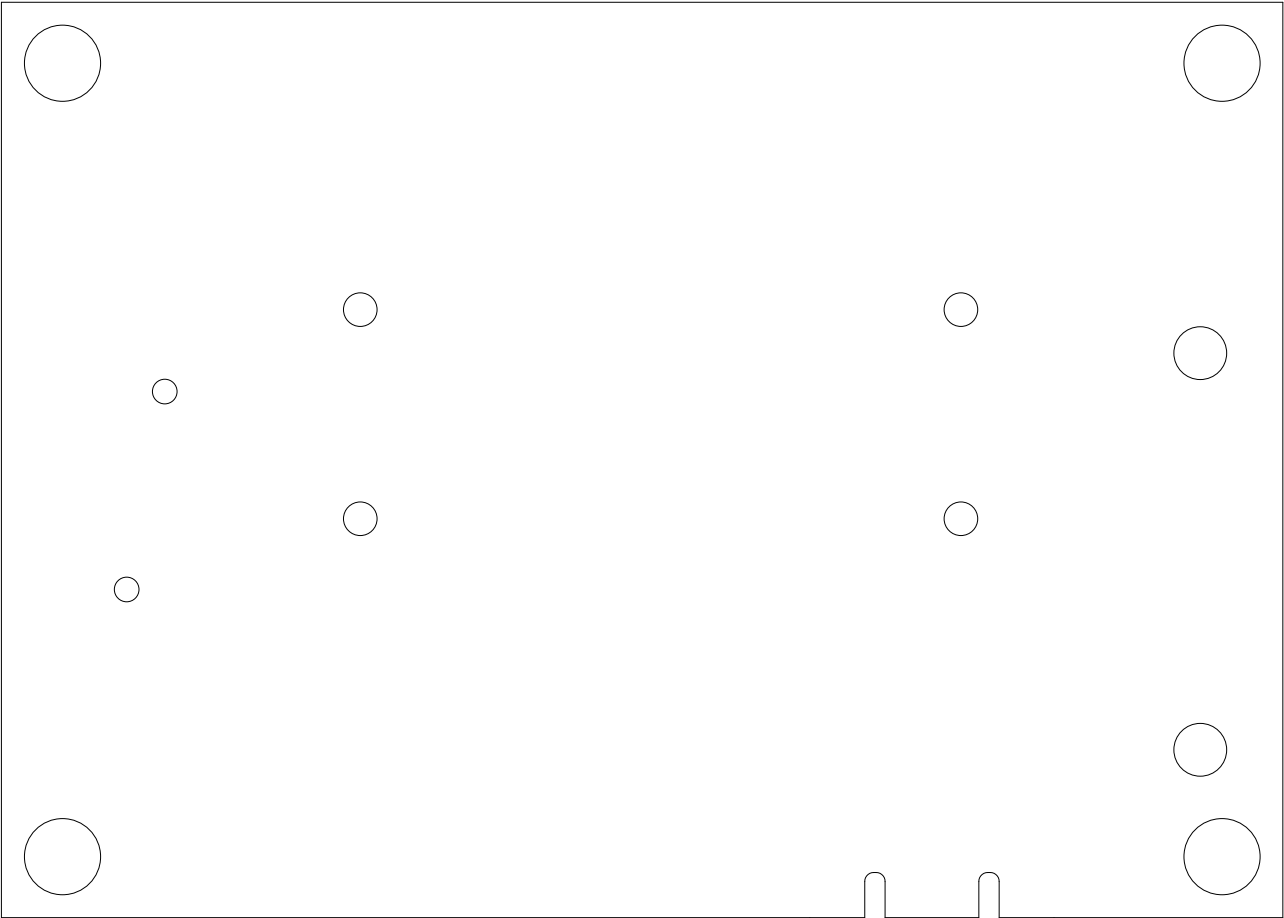

Top and Bottom Layers 1:1 Scale

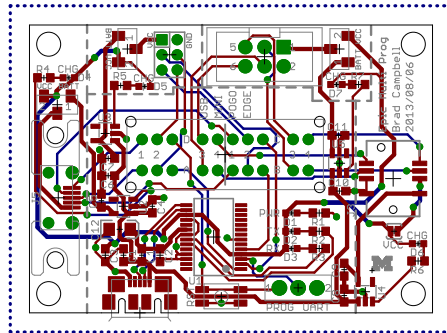

Top Layer 1:1 Scale

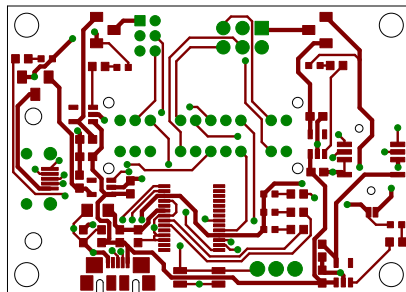

Bottom Copper Layer 1:1 Scale

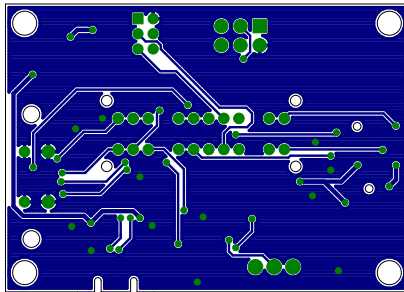

Sheet1

Qty	Value	Device
3	0.1u	C-EUC0603
8	1u	C-EUC0603
1	10u	CAP_POL1206
1	BLUE	LED0603
1	RED	LED0603
1	GREEN	LED0603
4	YELLOW	LED0603
1	EPIC-PROG-PORT	EPIC-PROG-PORT
1	MICRO_USB_B_HIROSE_ZX62R-B-5P	MICRO_USB_B_HIROSE_ZX62R-B-5P
1	MEC1-105-02-XX-XX-D-A	MEC1-105-02-XX-XX-D-A
1	TAG_CONNECT_HEADER_EPIC	TAG_CONNECT_HEADER_EPIC
1	MICRO_USB_B_MALE_HIROSE_ZX80-B-5S	MICRO_USB_B_MALE_HIROSE_ZX80-B-5S
1		INDUCTOR0603
7	470	R-US_R0603
1	TE_SSA12/SPDT	TE_SSA12/SPDT
1	CK_SS-44D04-G4/4P4T	CK_SS-44D04-G4/4P4T
1	EVQP2	EVQP2
3	COPAL_CJS-1200TA/SPDT	COPAL_CJS-1200TA/SPDT
1	FT232RL	FT232RL
4	MAX1555	MAX1555

Sheet1

Package	Parts
C0603	C1, C2, C3
C0603	C4, C5, C6, C7, C8, C9, C10, C11
EIA3216	C12
LED-0603	D1
LED-0603	D2
LED-0603	D3
LED-0603	D4, D5, D6, D7
HEADER2X3X2MM	J1
USB_MICRO_B-HIROSE-ZX62R-B-5P	J2
MEC1-105-02-XX-XX-D-A	J3
2X3_MALE_SHROUDED_0.100	J4
USB_MICRO_B_MALE-HIROSE-ZX80-B-5S 603	J5
R0603	L1
TE_SSA12/SPDT	R1, R2, R3, R4, R5, R6, R7
CK_SS-44D04-G4/4P4T	S1
EVQP2	S2
COPAL_CJS-1200TA/SPDT	S3
SSOP28	S4, S5, S6
SOT23-5L	U1
	U2, U3, U4, U5

Sheet1

Description	DIGIKEY	MOUSER
CAPACITOR, European symbol	445-1316-1-ND	
CAPACITOR, European symbol	445-1321-1-ND	
Capacitor Polarized	478-1655-1-ND	
LEDs	160-1837-1-ND	
LEDs	160-1835-1-ND	
LEDs	160-1834-1-ND	
LEDs	160-1184-1-ND	
	3M9173-ND	
USB Micro B Connector	H11574CT-ND	
	SAM8115-ND	
2x3 Male Shrouded Header 0.100	3M15451-ND	
CONN PLUG MCR USB B PCB VERT	H11612-ND	798-ZX80-B-5S
Inductors	240-2373-1-ND	
RESISTOR, American symbol	P470GDKR-ND	
SWITCH SLIDE SPDT 2POS SSA SER	450-1602-ND	
Through hole 4P4T switch.	CKN10389-ND	
	P11084SCT-ND	
SWITCH SLIDE SPDT SMD J-LEAD	563-1021-2-ND	
FTDI chip	768-1007-1-ND	
Dual-Input USB/AC Adapter 1-Cell Li+ Battery Chargers	MAX1555EZK+TCT-ND	

Sheet1

DIGIREEL

445-1316-6-ND

445-1321-6-ND

478-1655-6-ND

160-1837-6-ND

160-1835-6-ND

160-1834-6-ND

160-1184-6-ND

H11574DKR-ND

240-2373-6-ND

P470GDKR-ND

563-1021-6-ND

768-1007-6-ND

MAX1555EZK+TDKR-ND