

Output Voltage Selection

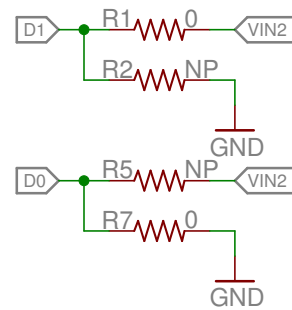

Top and Bottom Layers

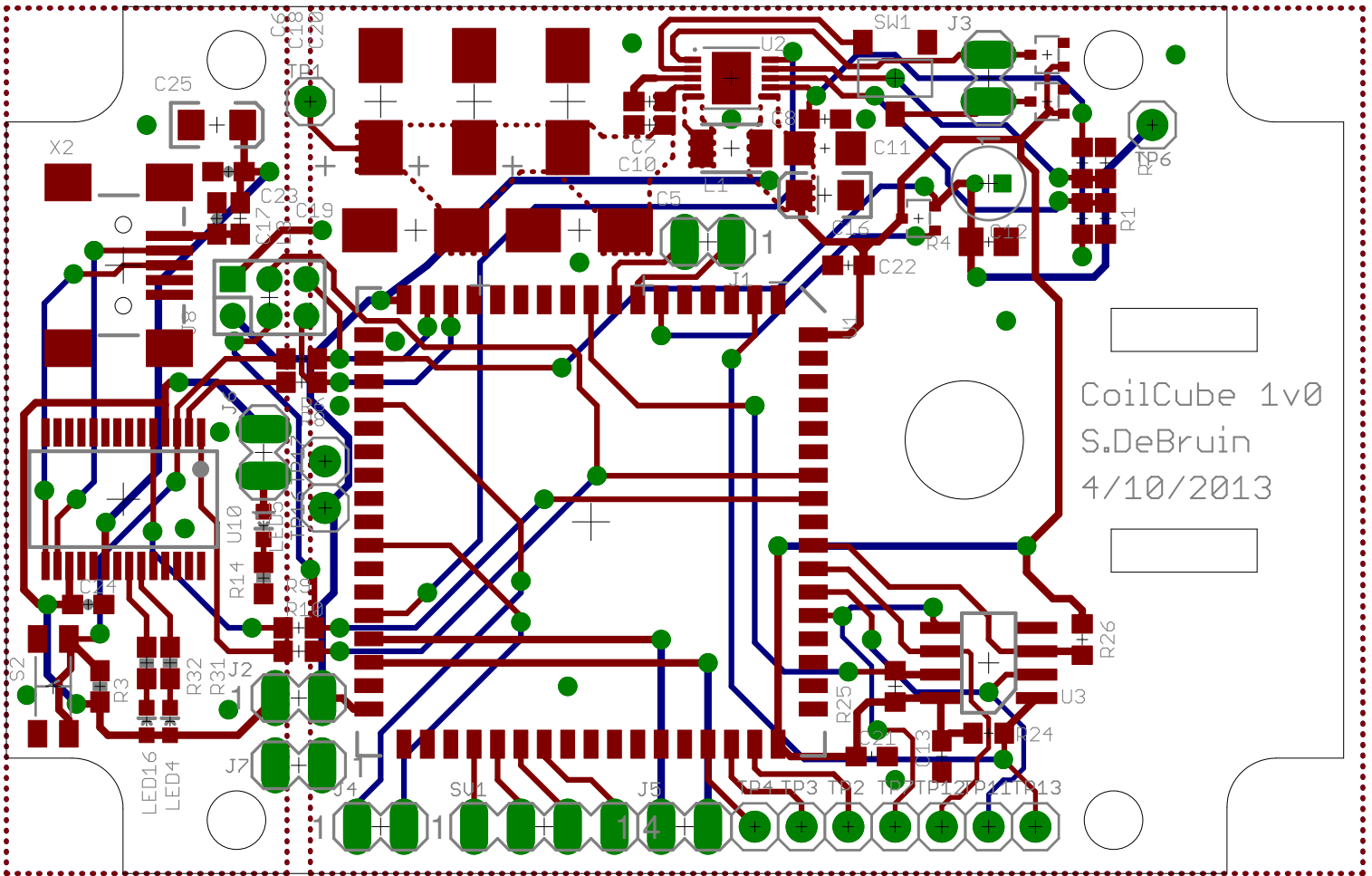

Top Layer

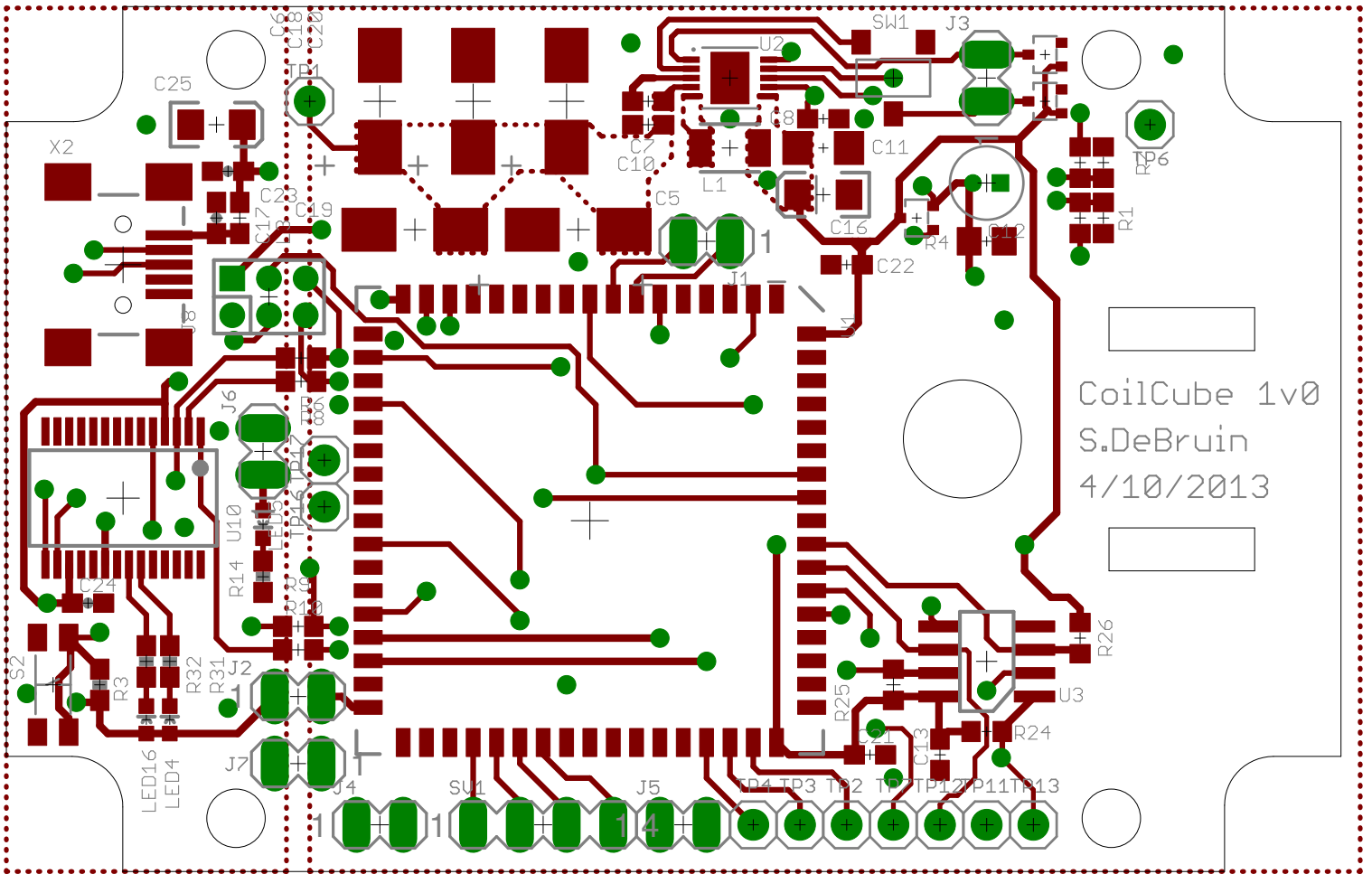

Bottom Layer

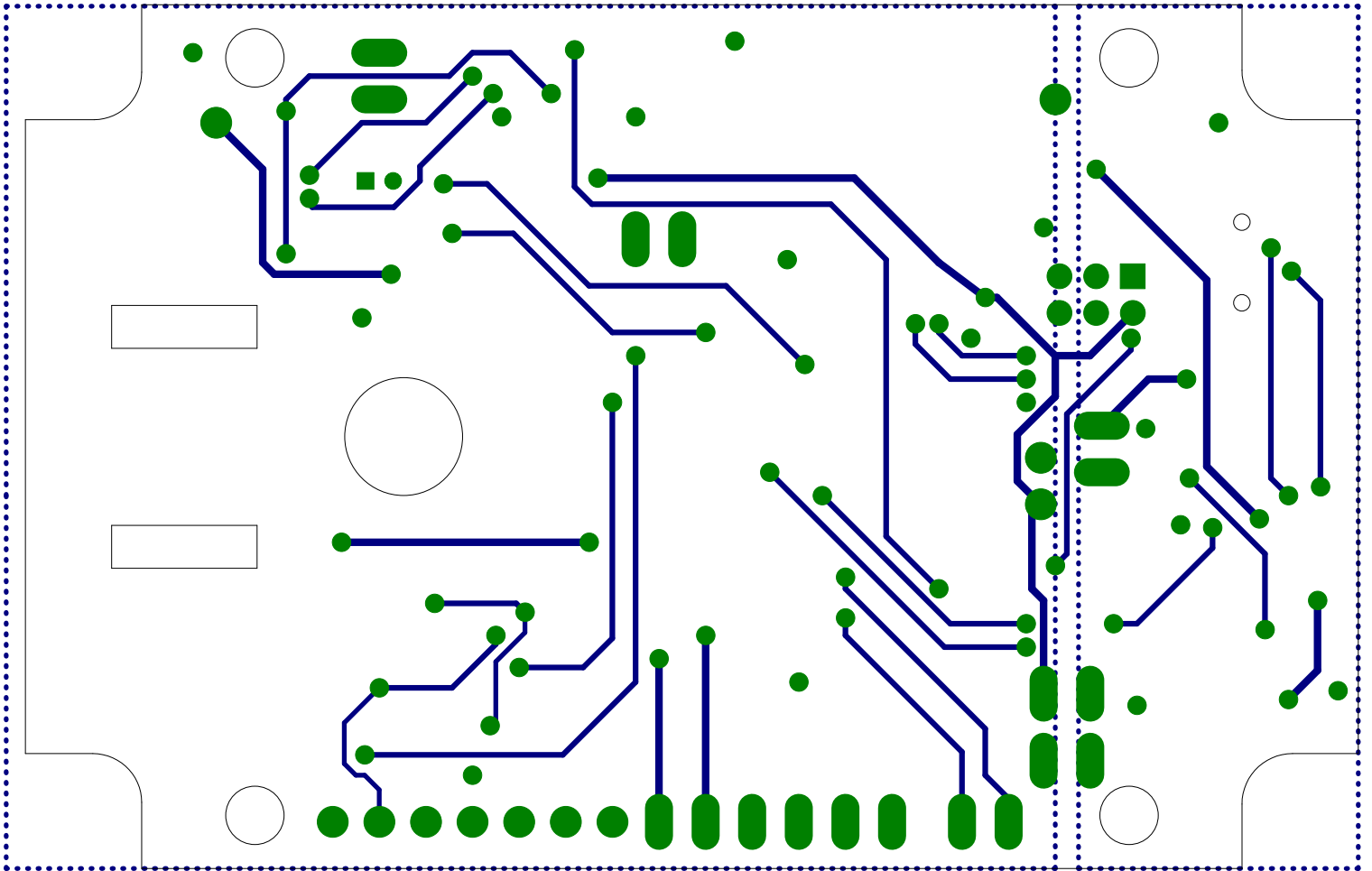

Top Copper Layer

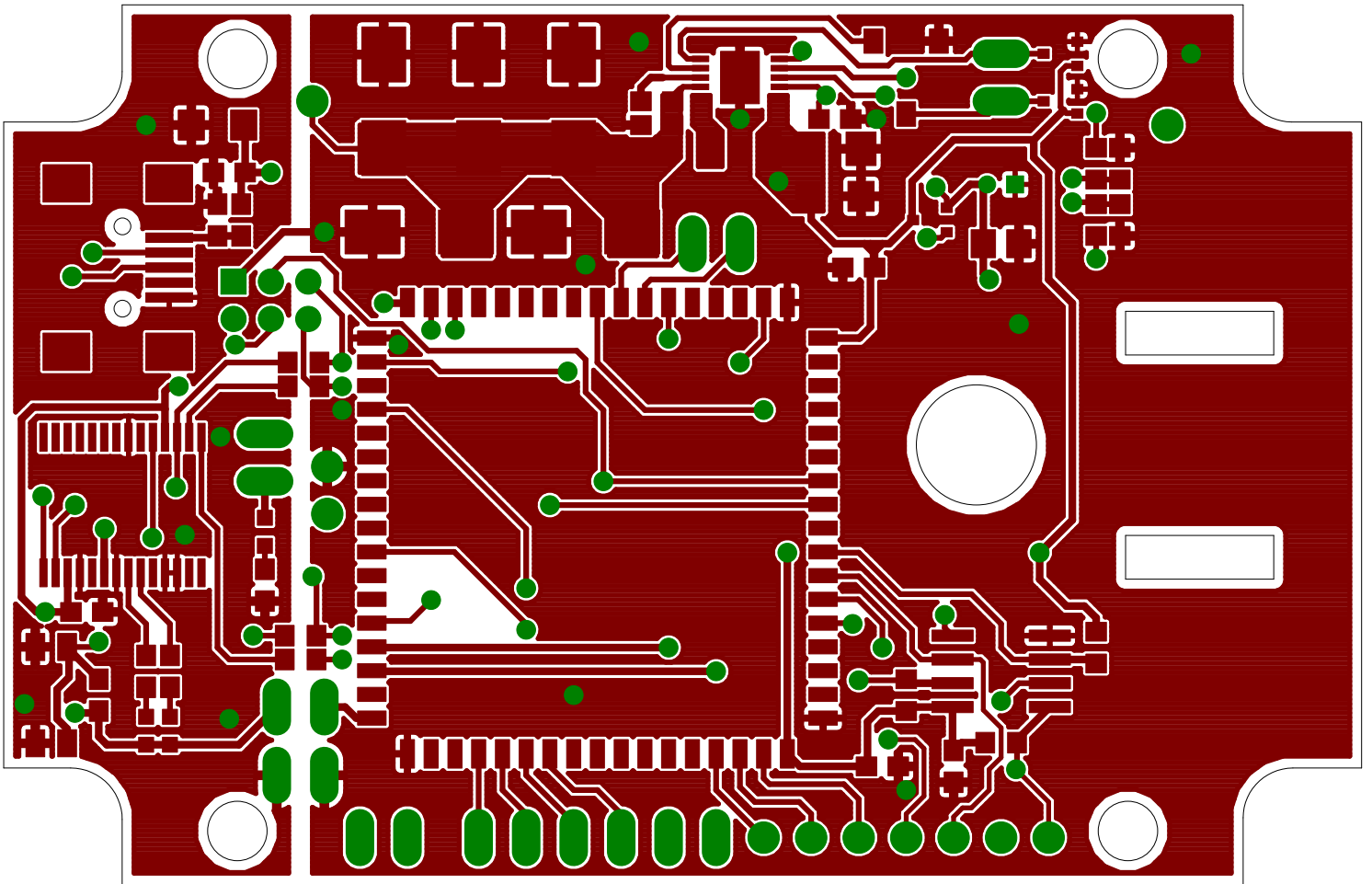

Bottom Copper Layer

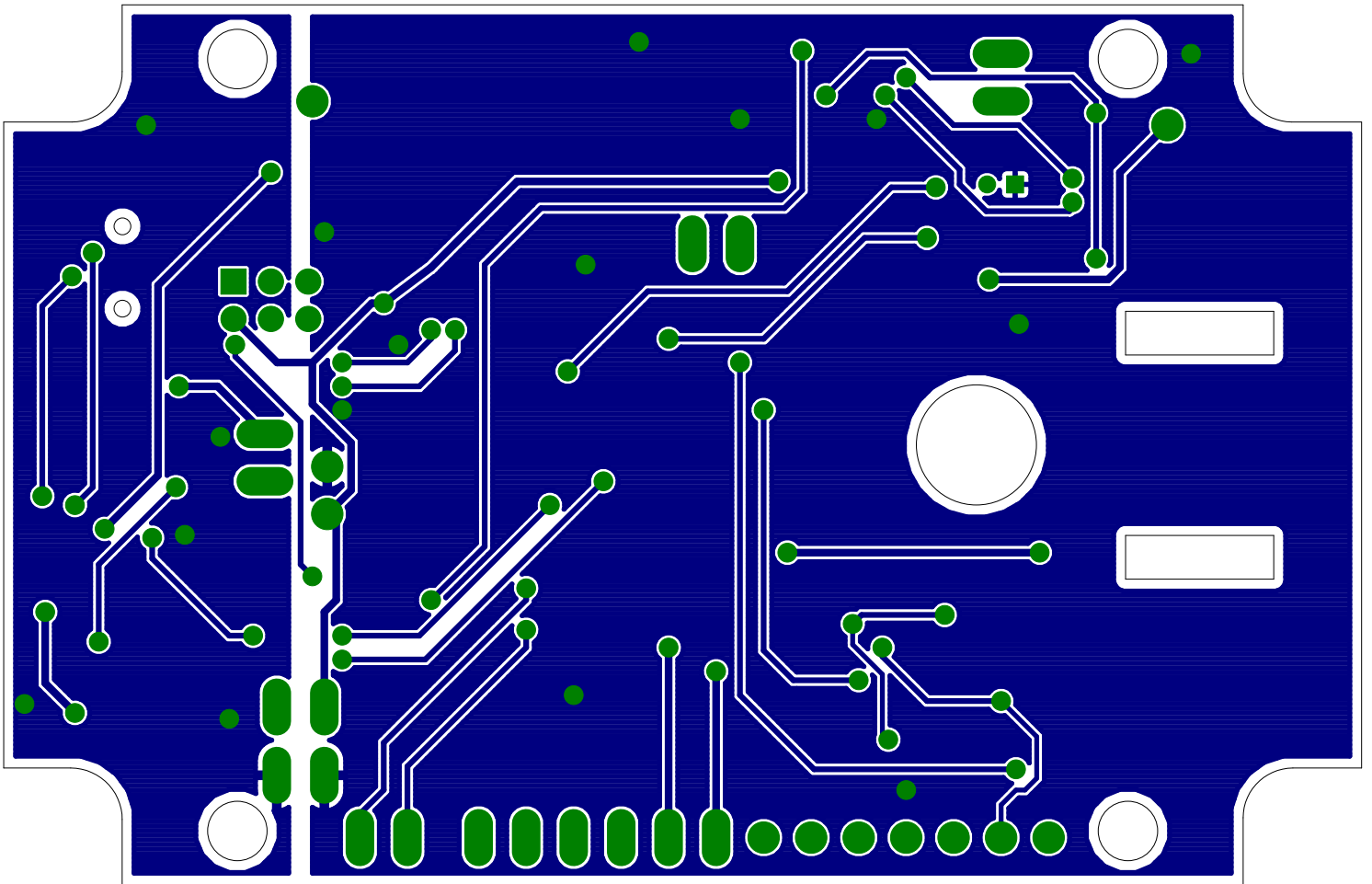

Top Paste Layer with Silkscreen

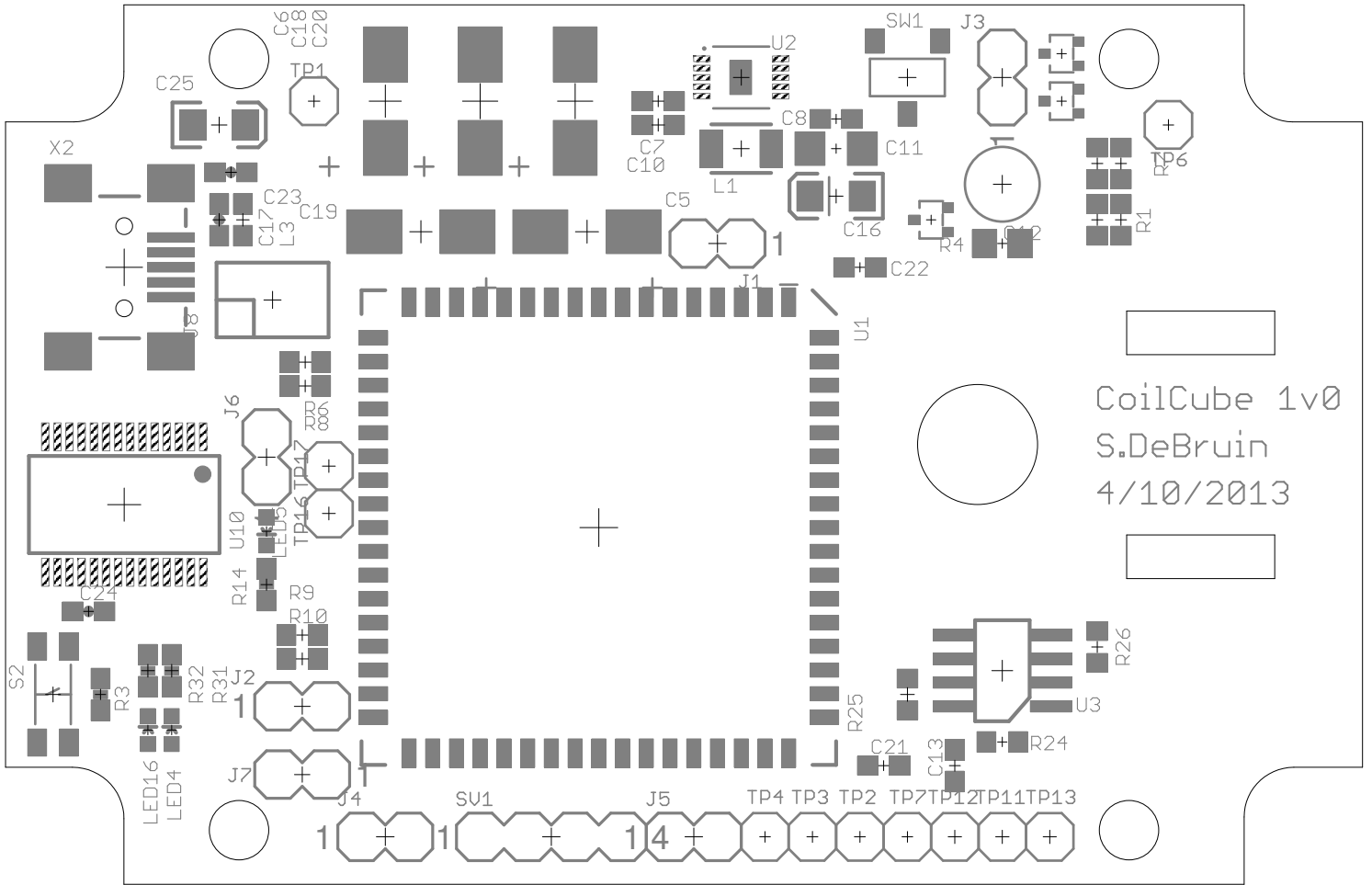

Bottom Paste Layer with Silkscreen

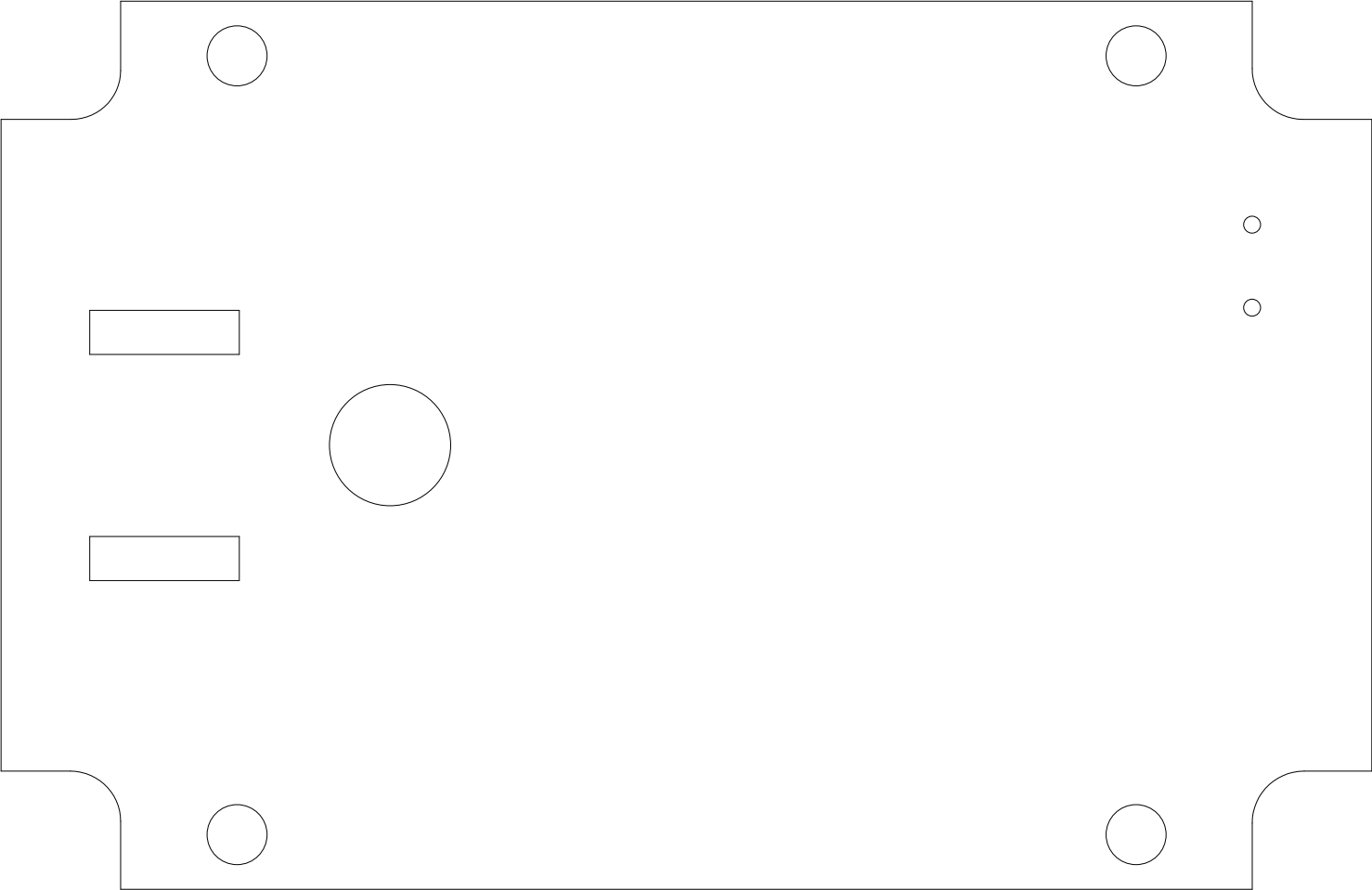

Top and Bottom Layers 1:1 Scale

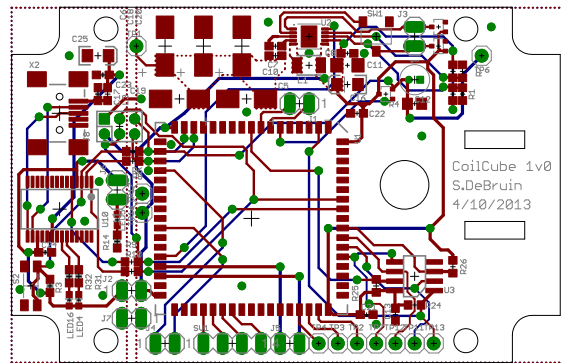

Top Layer 1:1 Scale

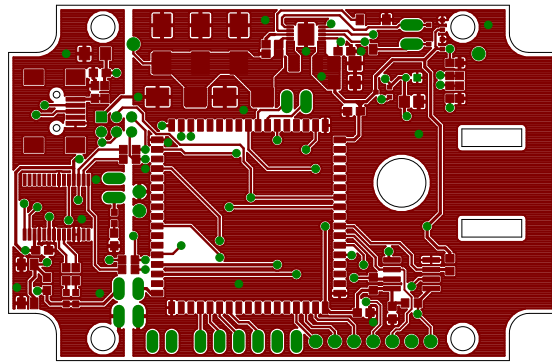

Bottom Copper Layer 1:1 Scale

